

Analysis of the overall stability of castellated beams under bending and torsion

Shier Dong ^a, Peng Wang ^b

School of civil engineering and architecture, Southwest Petroleum University, Chengdu 610500, China

^ads_xyz@sina.com, ^b347160956@qq.com

Abstract

Castellated beam is a steel structure with holes in the web of I-section steel beam after a certain process. Castellated beam has the characteristics of steel saving, high bearing capacity and attractive appearance, which has been widely used in practical engineering. However, due to the existence of eccentricity in practical engineering, castellated beam always supports the joint action of bending moment and torsion at the same time which makes the occurrence of unstable failure before the strength failure. Domestic and foreign scholars on the research of the beam condition of bending and torsion are mostly based on plain girder. In addition, on the basis of it, this paper has combined the finite element software ABAQUS to calculate the critical moment of Hexagonal hole castellated beams under the situation of different eccentricity, different pore ratio and hole spacing, which give the influence trend of each influence factor, so as to be referenced in the design of castellated beam.

Keywords

Castellated beam, Overall stability, Bend torsion condition, The finite element analysis.

1. Introduction

The castellated beam is one of the I-shaped steel structures, and the stability theory of the I-shaped steel structure has been studied for a long time, and many remarkable achievements have been achieved. But in China's "code for design of steel structure" (GB50017-2003)^[1] there is no formula of overall stability of castellated beams in bending state, only the solid web steel beam under transverse uniform load, concentrated the overall stability of solid beams and biaxial bending load, calculation formula. Our technical specifications "cold-formed steel structure" (GB50018-2002)^[2] formula of overall stability under combined bending and torsion bearing capacity of cold-formed steel was also given only, only for thin-walled steel structure. Thus it can be seen that the formulas prescribed by the relevant codes do not give the stability formula of the castellated beam under the bending and torsion state, and can not solve a large number of practical engineering problems. The whole honeycomb beam in and under bending and twisting stability calculation formula without clear validation, such components in practical engineering design, the designer can only be based on solid web beams combined with practical experience in engineering design, it may cause unnecessary waste, at the same time under simply supported castellated beam combined bending and torsion in flexural torsional buckling is how to influence the critical moment of simply supported castellated beams, the influence, and different span, section size, load type, load position change of lateral torsional buckling strength of I-shaped castellated beams is how to change, these are to be further the theoretical calculation and finite element analysis. There are two kinds of domestic research methods to study their overall stability. One is the theoretical study of energy method, and the other is the theoretical study of finite element method^[3,4].

ABAQUS software is developed by Dassault SIMULIA company developed for static and quasi static analysis, modal analysis, transient analysis, buckling analysis, fatigue analysis, structure analysis, can also sound and flow coupling analysis, acoustic coupling solid, especially the analysis of very complex problems and can simulate the highly nonlinear problems, ABAQUS nonlinear finite

element analysis software is extremely powerful. Based on the above considerations, the ABAQUS software is used to analyze the overall stability of the hexagonal hole simply supported beam under bending and torsion in this paper.

2. Establish a finite element model of castellated beam

2.1 ABAQUS model unit type selection

The I-shaped steel is composed of three pieces of welded steel plate, plate thickness thin, relatively large, so it is suitable for SHELL unit in ABAQUS. In this paper, the castellated beam is made of Q235 steel, the elastic modulus of steel and Poisson's ratio of $E = 2.1 \times 10^5 \text{ N/mm}^2$. According to the mechanics of materials, $G = E/2(1+\nu) = 8.07 \times 10^5 \text{ MPa}$ can be obtained. The essence of finite element analysis is to reduce the continuous model to discrete model, and the more discrete model, the closer it is to the actual situation. In the finite element analysis of the honeycomb beam, each model should be divided according to the specific size in each part, and the maximum grid size at the cross section is controlled at around 25mm. The calculation speed to meet the accuracy requirements and to ensure that the case, because the flange shape is regular, which is divided into rectangular grid, and the web due to the hole, the model itself is not continuous, so the shape of the triangle mesh web unit^[5,6,7] is more reasonable. The boundary conditions must be set up in the FEM software, the paper is the analysis of the overall stability problem about bending state of cellular beams, you need to take into account the lateral and torsional deformation of cellular beams, so the support also need to comply with no lateral displacement, but to be able to turn the head shaft and the spindle ends of beam webs. The bearing cannot rotate head. In this paper, ABAQUS simulation of bearing, displacement through the three directions of the lower flange of the beam end constraints, and constraints of lateral displacement and vertical displacement of the flange beam under the other end and limit the two ends of the beam on the flange lateral displacement to achieve the effect of simply supported^[6-10]. Specific as shown in Fig. 1:

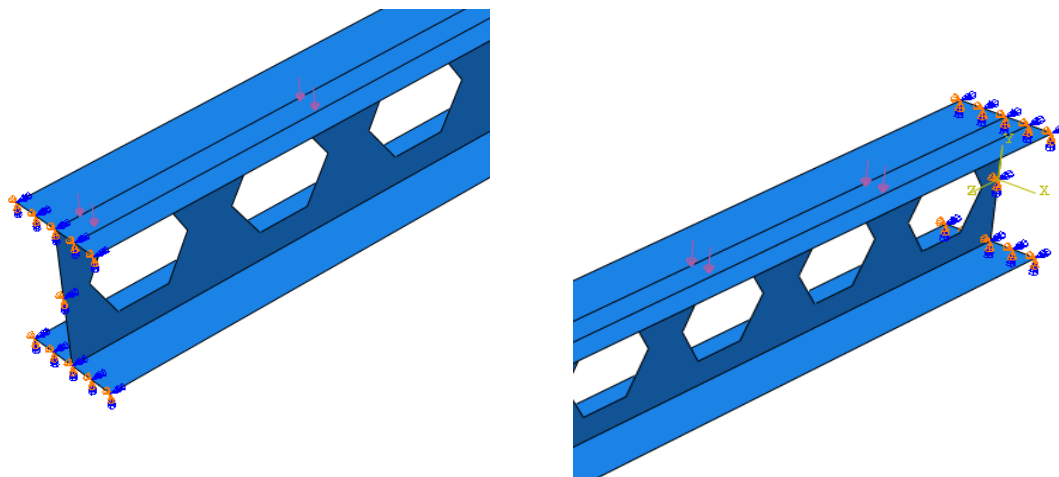

a) Left boundary condition of hexagonal hole castellated beam

b) Hexagonal hole; honeycomb beam; right boundary condition

Fig. 1 simple supported boundary conditions of cellular beam model

In this paper, the elastic flexural torsional buckling of castellated beams is studied. Assuming that the castellated beam is an ideal elastoplastic material and the yield criterion^[11-14] is observed, the finite element model established in this paper is shown in Fig. 2.

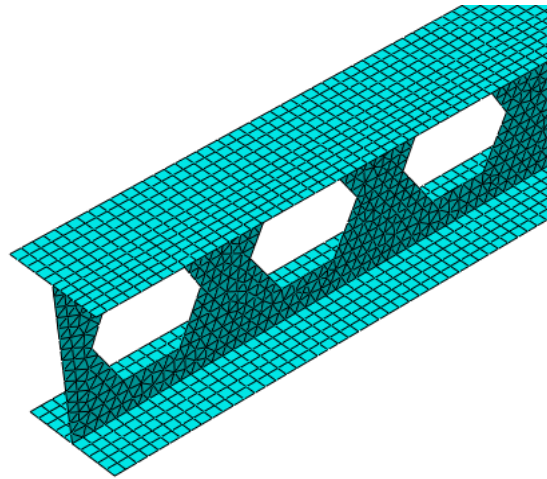

Fig. 2 Finite element model of castellated beam

2.2 Finite element analysis of castellated beams under bending and torsion

In this paper, the stability of castellated beam under bending and torsion is studied, and the model of hexagonal hole castellated beam is analyzed. The calculation diagram is shown in Fig. 3 and Fig. 4.

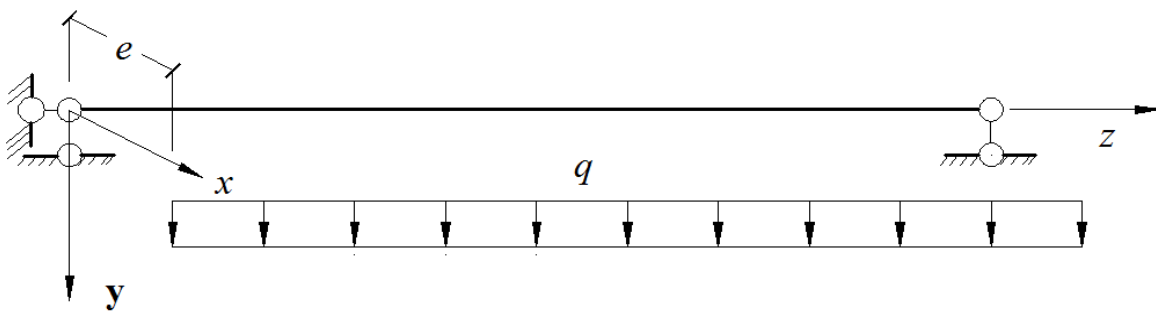

Fig. 3 Calculation diagram of simply supported castellated beam eccentricity under uniform load

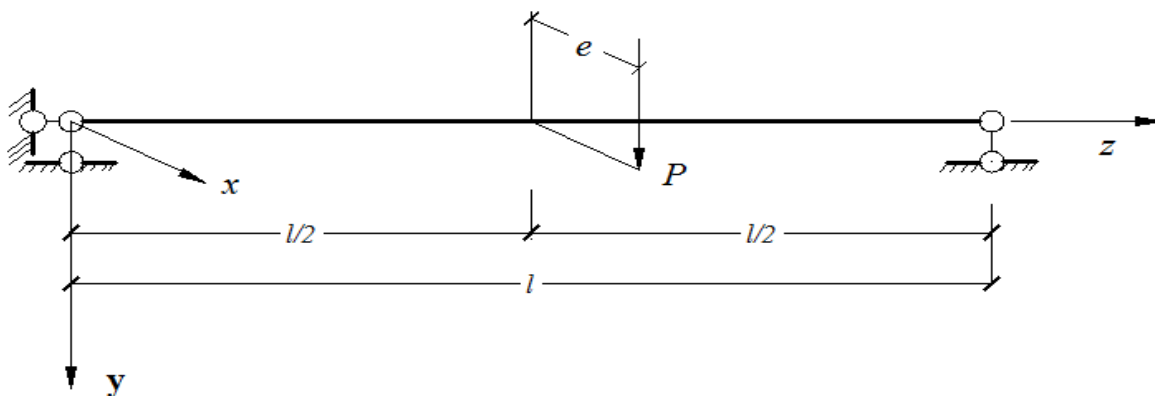

Fig. 4 Sketch of calculation for eccentric concentrated load of simply supported castellated beam

In this paper, the hexagonal hole castellated beam is analyzed by finite element method, and the sketch map of the parameters of the castellated beam is shown in Fig. 5. For finite element analysis of flexural torsional buckling of castellated beams, open hole on the cellular beam stiffness influence, mainly Opening height d and total cellular effects of beam height h ratio and the effect of hole spacing s and beam height h ratio. Consider the opening height and the distance between the holes is to consider the influence of castellated beam hole effect on the critical moment, this paper assumes that

the sum of the opening height d and the opening spacing s is the castellated beam height h , namely $d + s = h$; according to the beam section size commonly used in practical engineering, the basic model of the beam span, size and span Table 1 shows.

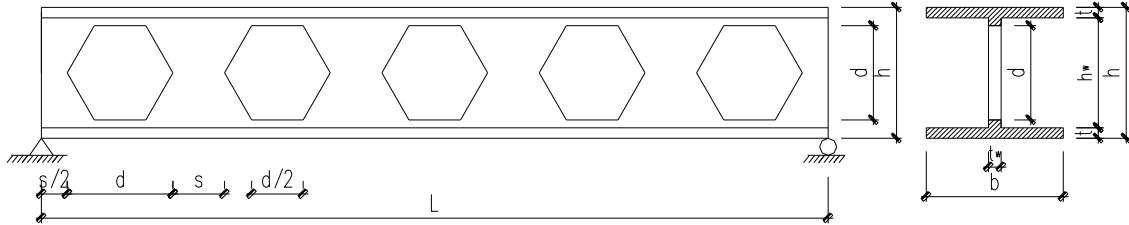

Fig. 5 Sketch of calculation parameters of castellated beams with six side holes

Table 1 basic section size and span of model beam

Component number	Component specification	Calculated span l (m)
1	400×180×10×12	4.8
2	400×180×10×12	6
3	400×180×10×12	12
4	500×250×12×15	4.8
5	500×250×12×15	6
6	500×250×12×15	12

3. Finite element analysis of flexural torsional buckling of simply supported castellated beams with hexagonal holes under bending and torsion

Finite element analysis of hexagon hole bending of simply supported castellated beam under the condition of loading, component diagram of Fig. 3 and Fig. 4, shown in Fig. 6 and Fig. 7, the flexural torsional buckling deformation of hexagon hole castellated beams simply supported subjected to uniform load buckling deformation is shown, load bias acts on flange eccentricity, respectively, $e=30\text{mm}$, $e=60\text{mm}$, $e=90\text{mm}$, $e=120\text{mm}$.

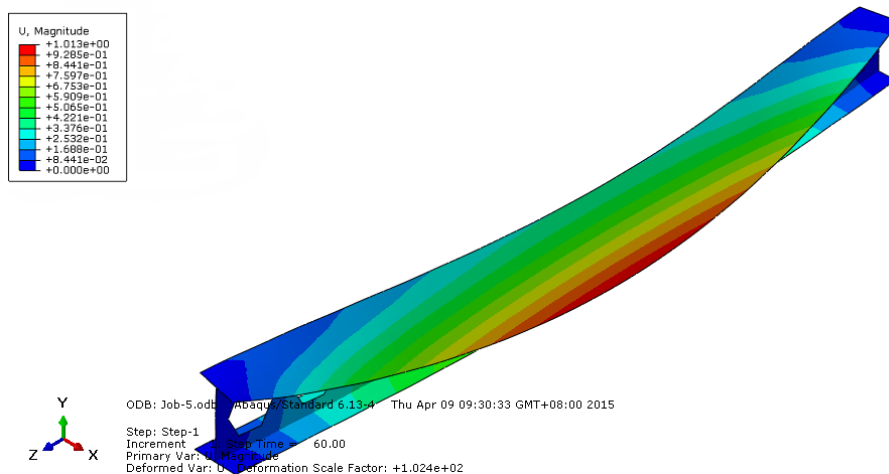

Fig. 6 buckling deformation of simply supported castellated beam with hexagonal hole under uniform load

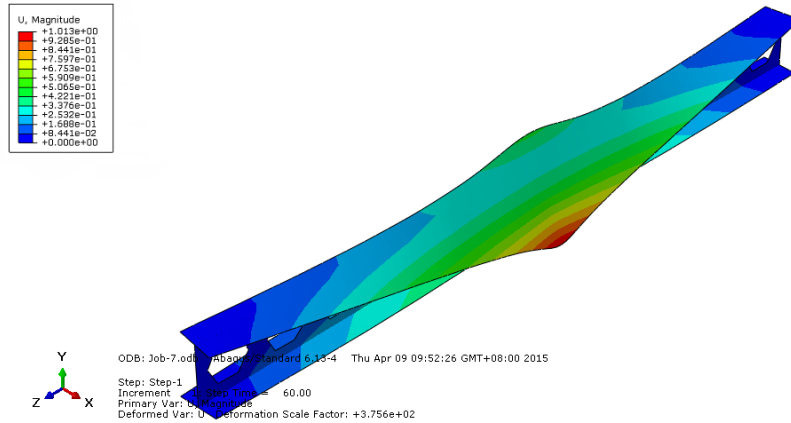

Fig. 7 buckling deformation of simply supported castellated beam with hexagonal hole under concentrated force

3.1 Analysis of factors affecting the overall stability of Castellated Beams

The change of a quantity is usually affected by a number of parameters. For the case of multivariable, the more commonly used method is the control variable method, which simplifies the problem of multiple variables into a single variable problem. The so-called control variable method is that every time a variable is taken as the research factor, the remaining variables are not changed under certain conditions. The change of the influence of the variable on the research question is analyzed. The control variable method is convenient for research and analysis, and is widely used in various research fields.

The overall stability of castellated beams is mainly affected by porosity, shape of openings, span depth ratio and other factors. It is assumed that the ABAQUS value is the critical critical moment of the component and the effect of various factors on the overall stability of the castellated beam is investigated.

The influence of eccentricity on the overall stability of Castellated Beams

The eccentricity e of unit is mm (mm) as the horizontal coordinates, with the formula

$$\frac{M_{\max}}{\phi_b W'_{ex}} + \frac{B}{W'_w} \leq f$$

to calculate the equivalent critical moment value of castellated beam critical moment calculation and finite element software ABAQUS value as the ordinate table, when the eccentric distance of castellated beams, in order to reflect the ABAQUS finite element solution and the error change solution theory, drawing on the results:

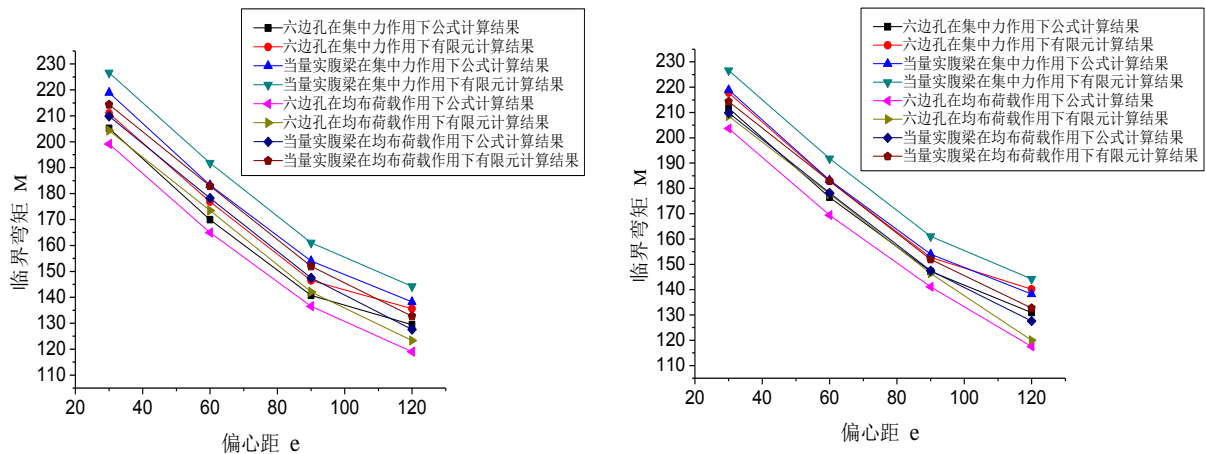

Fig. 8 Comparison of calculation results of component 1 under the state of bending and torsion at the six side opening $s/h=0.3$ and 0.5

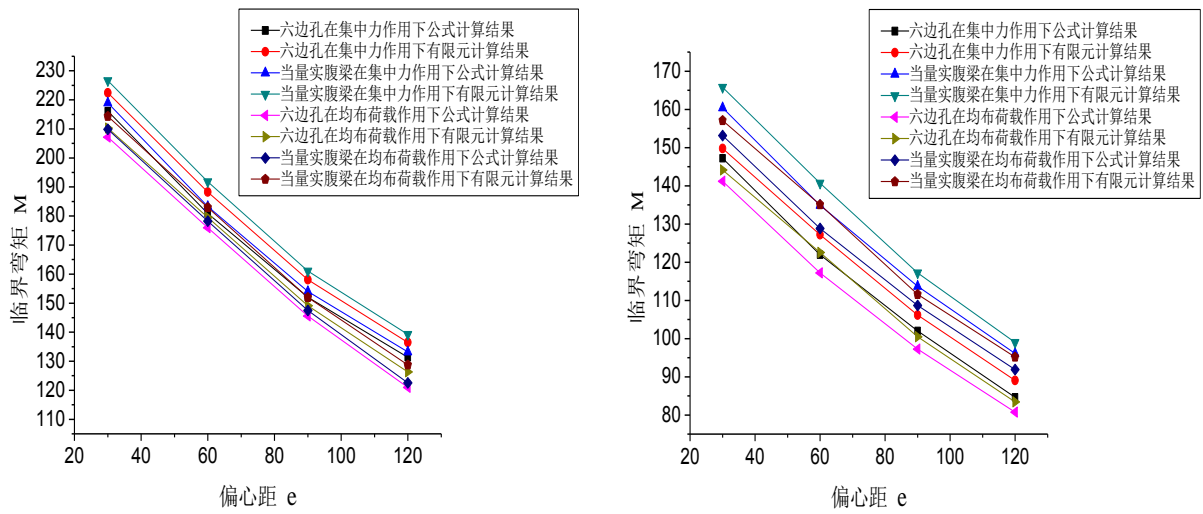

Fig.9 comparison of calculated results of component 1 at the six side opening hole $s/h=0.7$ and component 2 at the six side opening hole $s/h=0.3$

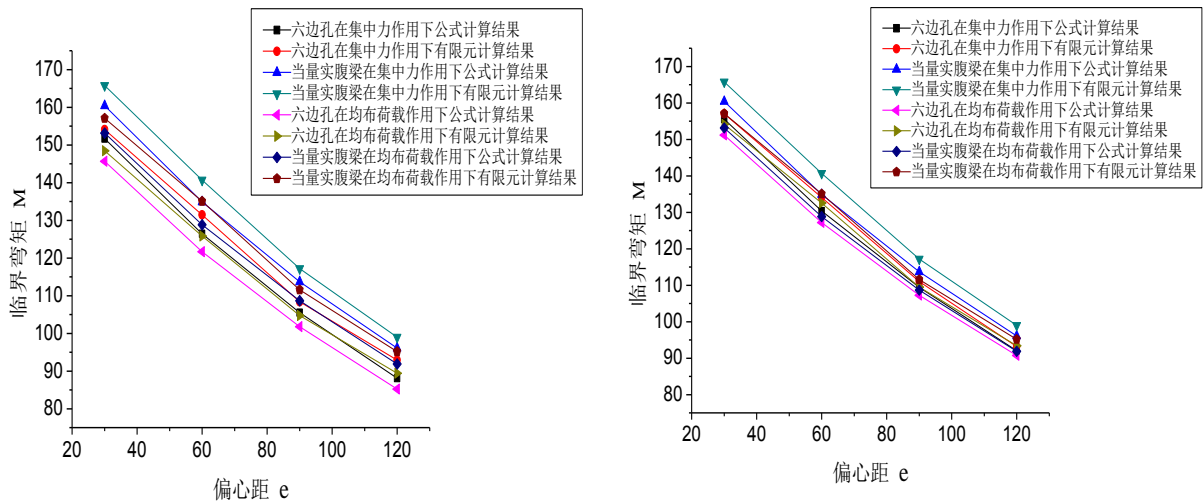

Fig. 10 comparison of calculation results of component 2 under the state of bending and torsion at the six side opening $s/h=0.5$ and 0.7

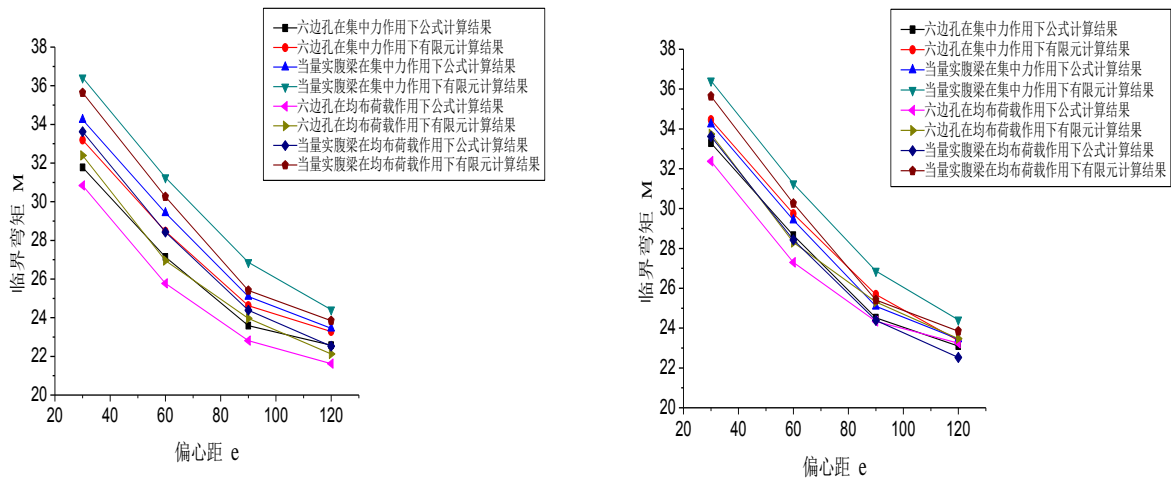

Fig. 11 comparison of calculation results of component 3 under the state of bending and torsion at the six side opening $s/h=0.3$ and 0.5

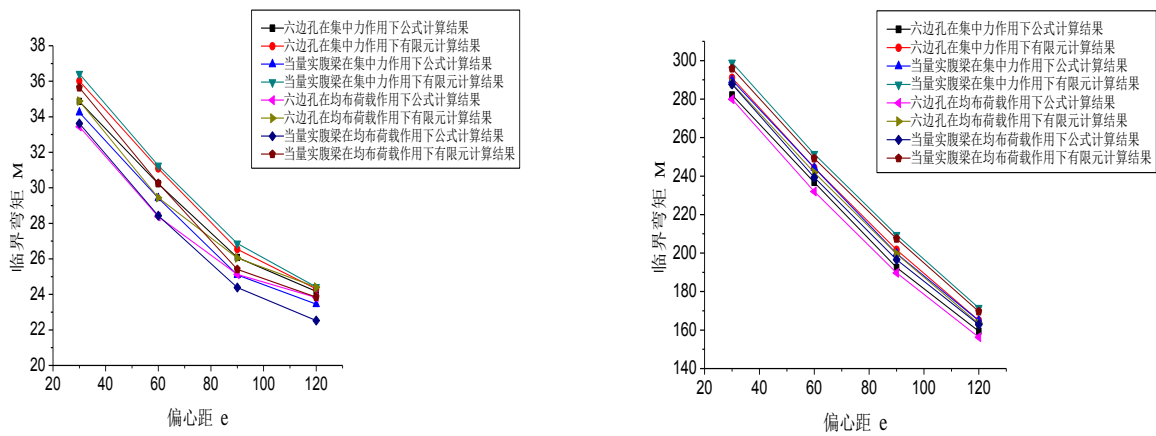

Fig. 12 comparison of calculated results of component 3 at the six side opening hole $s/h=0.7$ and component 4 under the state of bending and torsion at hexagon opening $s/h=0.3$

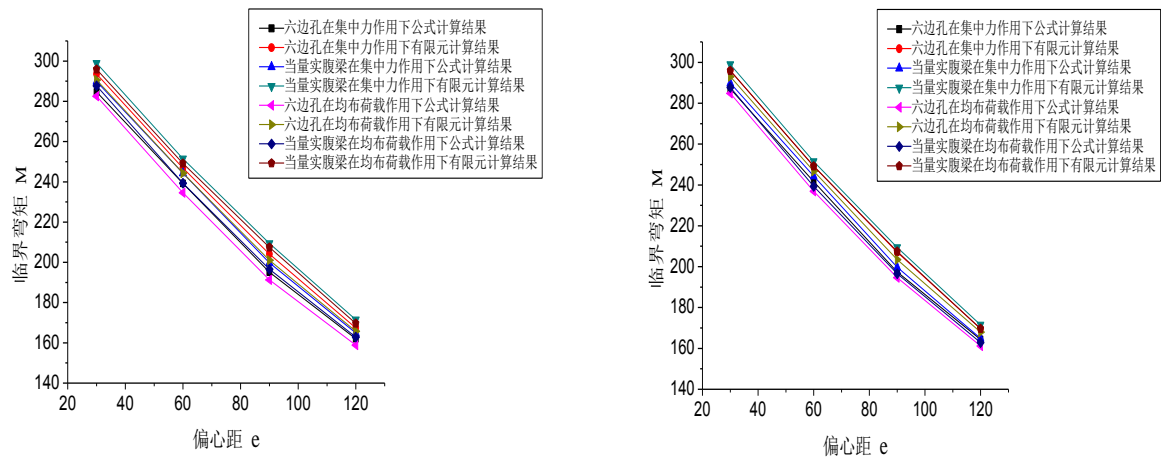

Fig. 13 comparison of calculation results of component 4 under the state of bending and torsion at the six side opening $s/h=0.5$ and 0.7

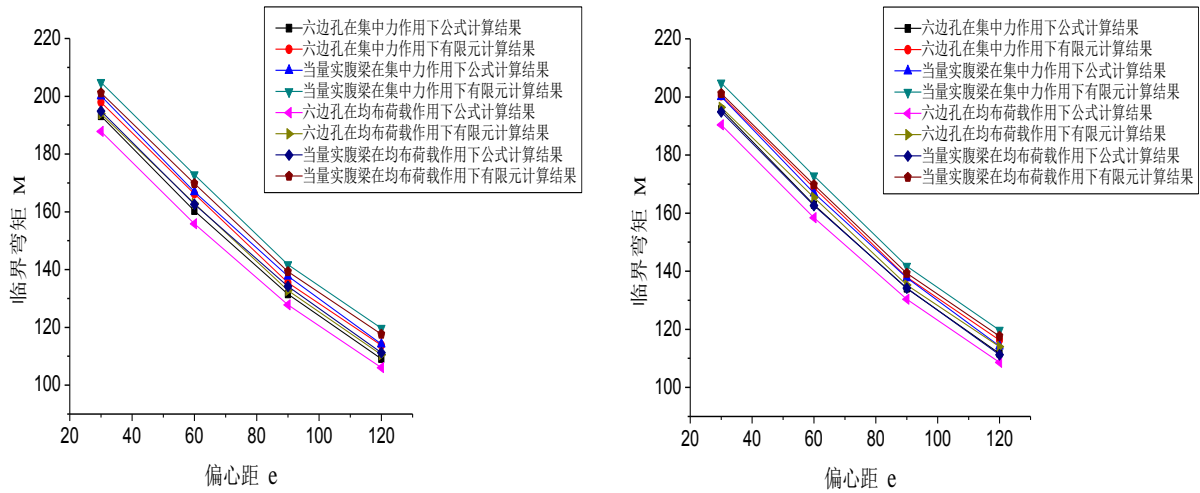

Fig. 14 comparison of calculation results of component 5 under the state of bending and torsion at the six side opening $s/h=0.3$ and 0.5

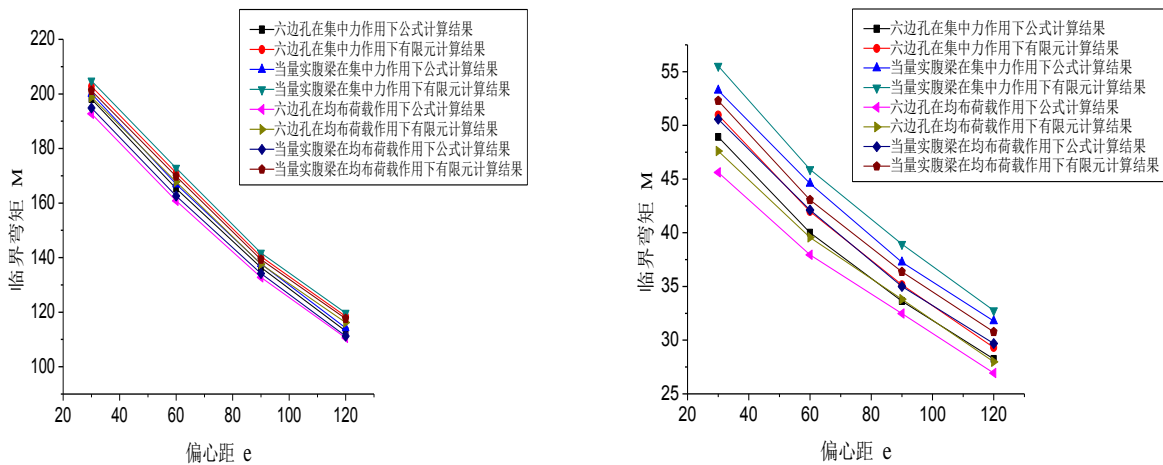

Fig. 15 comparison of calculated results of component 5 at the six side opening hole $s/h=0.7$ and component 6 under the state of bending and torsion at hexagon opening $s/h=0.3$

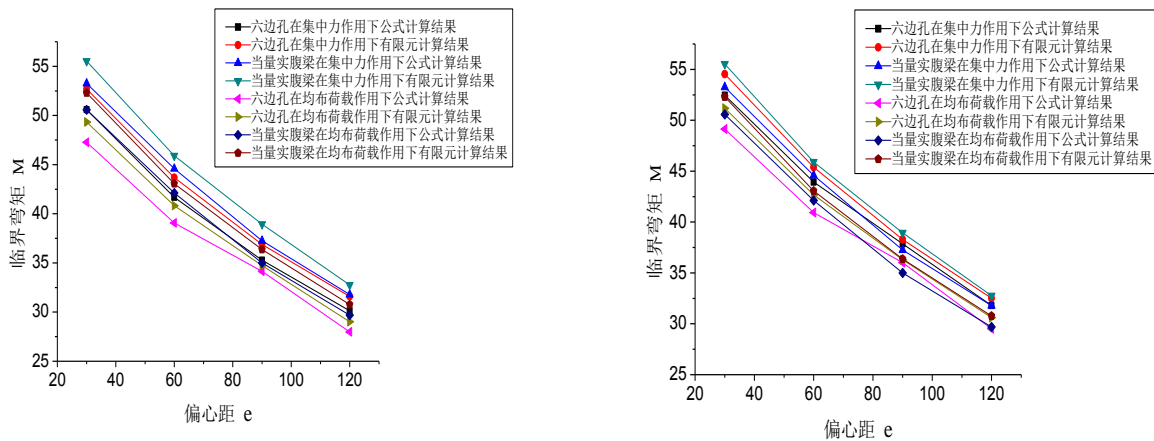

Fig. 16 comparison of calculation results of component 6 under the state of bending and torsion at the six side opening $s/h=0.5$ and 0.7

It can be summed up by the figure above:

(1) the uniform load for the calculation of the two kinds of load form eccentric concentrated force and eccentric load, when the eccentricity is the critical moment of smaller eccentric uniform critical moment loads than the eccentric and concentrated load, so the castellated beam relative eccentric concentrated load, eccentric load more unfavorable.

(2) obviously, due to eccentricity due to the existence of castellated beam bearing capacity of the overall decrease in honeycomb beam section size, span, opening a certain distance, the greater the eccentricity is greater torque, the critical moment of castellated beams is smaller. When the eccentricity is small (mm), the critical moment decreases with the increase of the eccentricity, and the specific reflection in the diagram is that the slope is greater; with the increase of the eccentricity, the critical moment changes gradually. With the increase of the span of the component, the overall trend of each eccentric distance is consistent. For example, the total variation trend of the 1, 2 and 3 components at the eccentricity of 30mm, 60mm, 90mm and 120mm is the same.

(3) the overall trend summarized above, the finite element software ABAQUS calculation results than the theoretical calculation results to some, that formula is conservative, both eccentric and concentrated load or eccentric load, with the increase of eccentricity will cause the decrease of the critical moment, the hexagonal hole with a circular opening the difference in the same hole eccentricity is small, but when the increasing trend changes from both eccentric and solid beams is the same, it also illustrates the correctness and rationality of the finite element model.

3.1.1 Influence of span depth ratio on the overall stability of castellated beam under bending and torsion

Span depth ratio l/h refers to the height of castellated beam span and Section height ratio, whereas the model section size in this paper is of two kinds, in order to observe effects of Span depth ratio on the overall stability of castellated beams, the structure here will be classified, No. 1 ,2 and 3 component is classified as a I component, by section No. 1,2 and 3 the height is 400mm, only the different span, select the same hole condition, force, eccentricity position to draw the influence of span ratio on the overall stability of castellated beams. Similarly, No. 4, 5, and 6 are collectively referred to as II components.

By using l/h as the abscissa, the critical bending moment of the castellated beam and the ABAQUS finite element calculation value are in ordinate, as shown in Fig. 17 to Fig. 32:

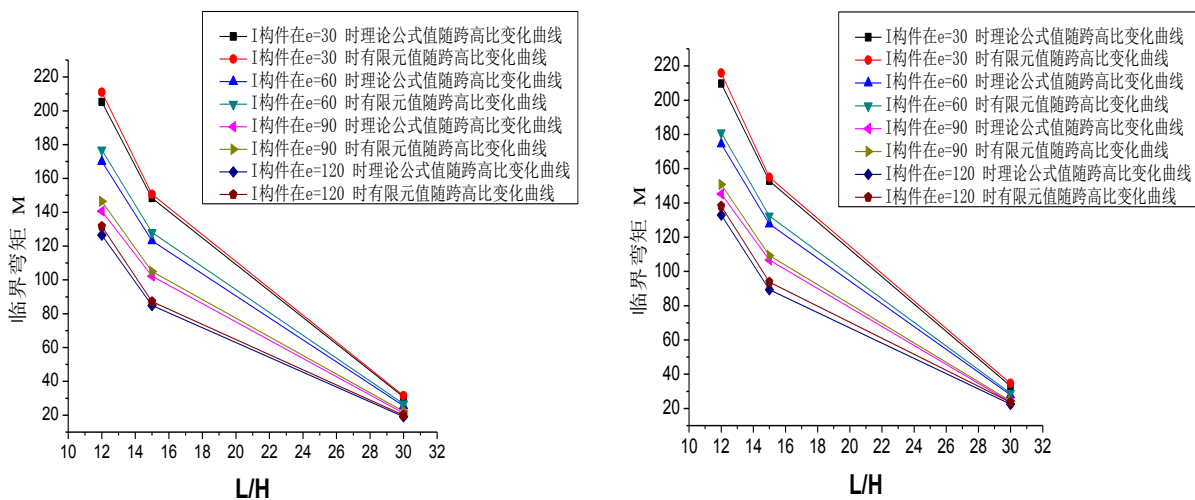

Fig. 17 comparison analysis of critical moment of I component with span height ratio under $s/h=0.3$ and 0.5 under concentrated force six side opening

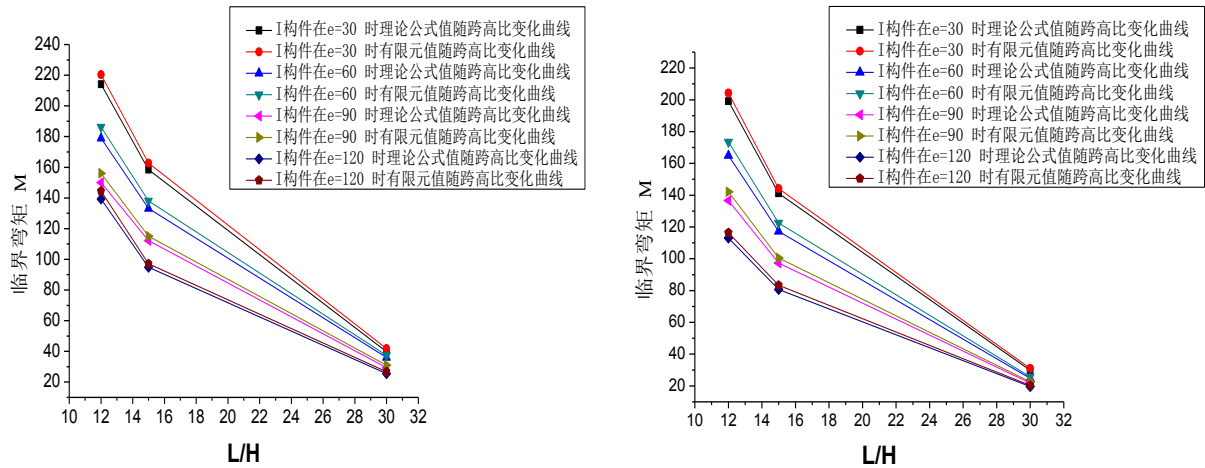

Fig. 18 the critical moment of the I member under the uniform load and the I member under the uniformly distributed load $s/h=0.3$ and the member under the uniformly distributed load $s/h=0.7$, the contrast analysis is made with the change of span height ratio

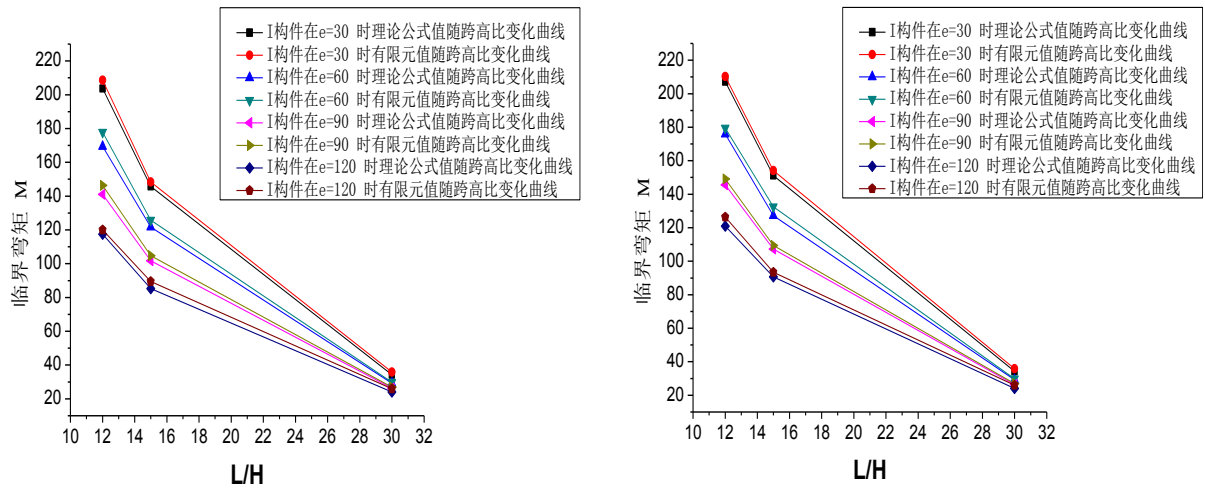

Fig. 19 comparison analysis of critical moment of I component with span height ratio when $s/h=0.5$ and 0.7 are open at six sides of uniformly distributed load

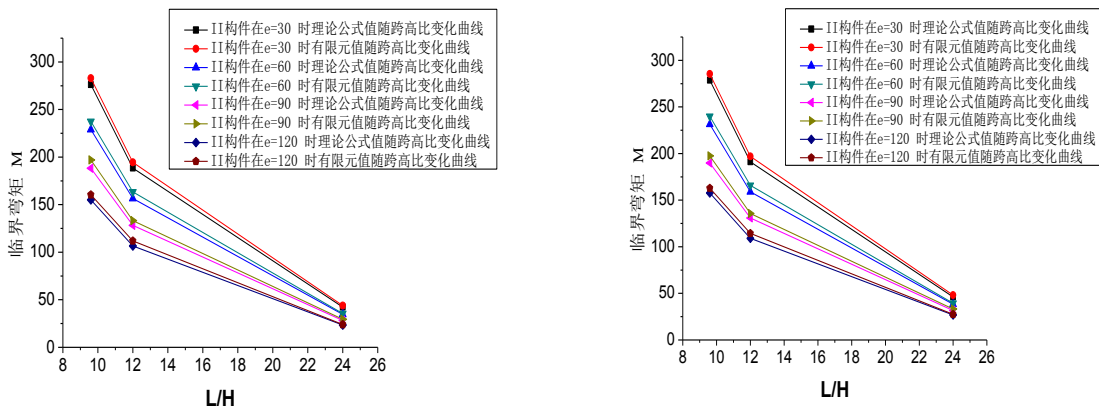

Fig. 20 comparison analysis of critical moment of II component with span height ratio when the member is concentrated at six sides and the aperture is $s/h=0.3$ and 0.5

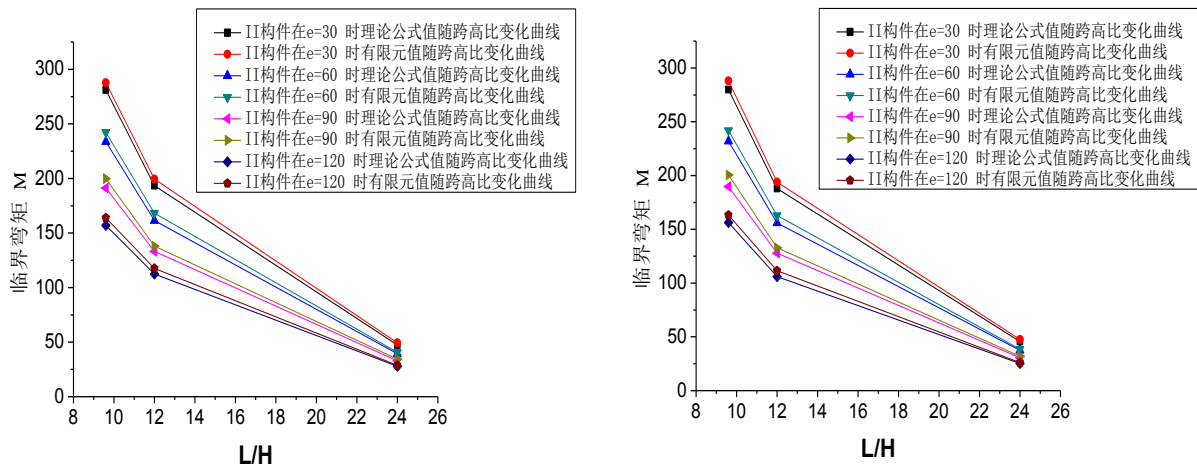

Fig. 21 the critical moment of II member under concentrated load, $s/h=0.7$ and II under the uniformly distributed load, the member is contrasted and analyzed with the change of span height ratio ($s/h=0.3$)

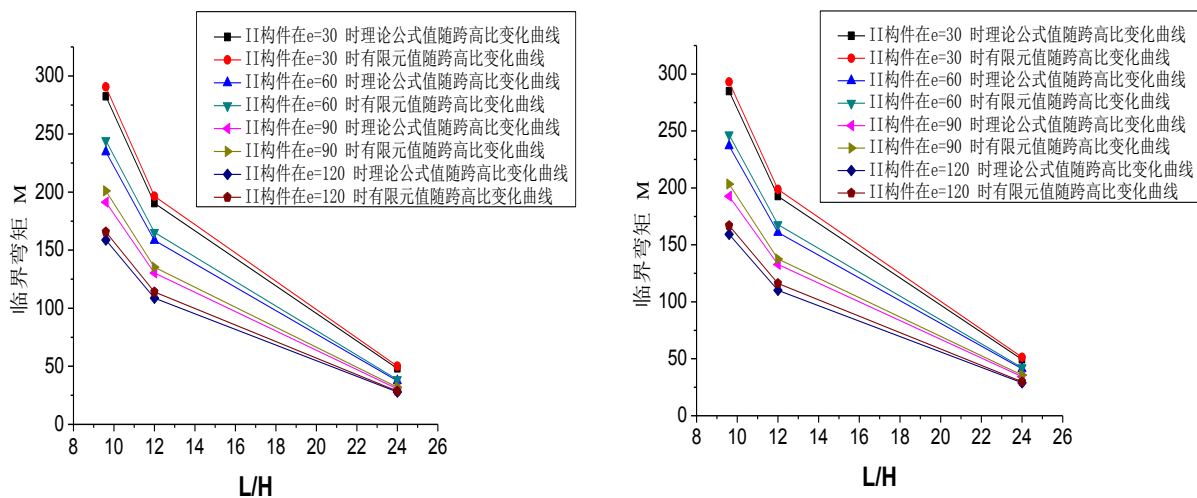

Fig.22 comparison analysis of critical moment of II component with span height ratio when $s/h=0.5$ and 0.7 are open at six sides of uniformly distributed load

It can be summed up by the figure above:

(1) for simply supported castellated beam, from the figure that affect the overall stability of castellated beams increases with the increase of span ratio; concrete manifestation is when the I component $l/h < 15$, II component $l/h < 12$, the line slope diagram is larger, that is to say when the span is less than 6m, the critical moment of the beam with high cross cellular ratio a significant influence, but when more than 6m lines component diagram flat, that is the critical moment of honeycomb beam changes with the span depth ratio effect began to decrease. The cellular beam is larger, the critical moment will more. But with the increase of the span of castellated beams, the critical bending moment shows a downward trend, which shows that the span depth ratio of castellated beams can be regarded as a typical feature under the condition of bending and torsion.

(2) when the Span depth ratio l/h increases, the eccentricity, hole is higher than under the conditions of the trend is basically the same, have good uniformity, which changes with the solid beams is also consistent, can refer to the design experience of solid beams in span design.

(3) comparative analysis of I component and II component, in the span l and eccentricity e under the same conditions, the critical moment of growth with the increase of the compression flange width, And decrease with the increase of eccentricity, change rate is quite obvious, but the trend is consistent with the trend of solid web beam so, increasing the compression flange width can significantly improve the overall stability of steel beam bearing capacity limit.

(4) when the span is smaller, the slope of the critical moment varies with the eccentricity, which shows that the ultimate load decreases with the increase of the eccentricity. The larger the span is, the smaller the slope of the critical moment varies with the eccentricity, and the trend of the ultimate load tends to decrease with the increase of the eccentricity. In the same section and eccentricity under certain circumstances, the critical moment decreases with the increase of the span, with the span increasing, the critical moment of the curve slope of castellated beam with the span of change is small, and this trend tends to slow the known solid beams change trend is consistent, suggesting a correlation.

4. Summary

(1) using ABAQUS finite element software to simulate the castellated beam, simulate the flexural and torsional buckling of the hexagon and round castellated beam of simply supported castellated beam under the bending and torsion state, and obtain the corresponding critical moment load.

(2) the overall stability of castellated beam is analyzed with the change of eccentricity and span. It is found that the critical moment of the castellated beam is closer to the critical moment of the spandrel beam when the increase is increased. The critical moment of comparison of honeycomb beam critical moment and solid beam, found that the bearing capacity of the bearing capacity and solid beams vary in a certain range, the eccentricity, the size of the hole and the two span of the honeycomb beam in bending and torsion conditions affect the overall stability when mutual restriction. It also provides reference for the practical design of castellated beams.

References

- [1] National Standard of People's Republic of China. Code for design of steel structures (GB50017-2003) [S]. Beijing: China Planning Press, 2003, 22-25
- [2] People's Republic of China national standard. Technical specification for cold-formed thin-walled steel structures (GB50018-2002) [S]. Beijing: China Planning Press, 2002, 21-30
- [3] Chen Shaofan. *Guide to the stability design of steel structures*. [M]., Second ed. Beijing: China Construction Industry Press, 2004:95-98
- [4] Chen Ji. *The Theory and Design of Steel Structure Stability*, Sixth Edition [M]. Beijing: Science Press, 2014
- [5] Yang Yinghua, Zhang Mi. Stability Checking of Steel Beams Under Biaxial Bending And Torsion [J]. steel structure, 2008, 23 (5): 7-10
- [6] Wang Xuefei, Wang Tiehong. Discussion On The Design Method of Steel Beam Torsion [J]. chemical engineering, 2009, 19 (3): 43-47
- [7] Penley. *Study on the overall stability of I-shaped steel beams under combined bending and torsion* [D]. Changsha: Hunan University, 2010, 18-21, 33-58
- [8] Li Pengfei, Yao Qianfeng, Guo Meng. Analysis of Flexural Torsional Buckling of Castellated Beam And Calculation of Its Overall Stability [J]. Beijing: Journal of Beijing Jiaotong University, 2010,
- [9] Hu Hu. *Study on overall stability of I-shaped section steel beam under combined bending and torsion* [D]. Changsha: Hunan University, 2011, 24-27, 53-57
- [10] Chen Caihong. *Study on the overall stability of single axis symmetrical I-beam under combined bending and torsion* [D]. Changsha: Hunan University, 2013, 11-14,
- [11] Wang Yuzhuo, Fu Cheng. ABAQUS. Structural Engineering Analysis And Detailed Examples. [M]. Chinese architecture and Building Press, 2013, 1-83
- [12] Xu Bingye, Liu Xinsheng. Applied Elastoplastic Mechanics [M]. Beijing: Tsinghua University press, 2003,92-125

- [13] Wang Jinchang, Yekai Chen. *ABAQUS in civil engineering*[M]. Hangzhou: Zhejiang University press, 2006, 1-40
- [14] Zhuang Zhuo. *ABAQUS nonlinear finite element analysis* [M]. Beijing: Science Press, 2005, 1-30