

Simulation of PDC bit cutting and rock breaking

Derong Zhang ¹, Zhihao Yang ²

¹ School of Southwest Petroleum University, Chengdu 610000, China

² School of Southwest Petroleum University, Chengdu 610000, China

Abstract

As we know, there is a very special bit, and its geometry parameter is a very significant impact factor on cutting efficiency and working performance. The mechanical analysis of PDC bit based on the analysis of the working performance of the bit. But the working place of the drill is deep underground, So the drilling system will be affected by many uncertain factors. Such as the nature of the rock, the formation of the different degree of flexibility, etc. This makes the mechanical analysis of the drill bit very difficult. We must make a mathematical modeling of the drill through the computer. Through simulation technology to understand and study the distribution and drilling process of the drill bit in the bottom hole. This paper through reference to various literature, mainly in the following aspects to do the relevant research: (1) Sum up the domestic and foreign research technology information, in order to understand the current status and development of PDC bit; (2) Using computer simulation technology to simulate the drilling process of PDC composite sheet, and understanding of its working mechanism. And through the analysis of the structure, movement mode and force of the cutting teeth of PDC drill bit, and combined with the finite element method and ABAQUS finite element software, The finite element analysis model of PDC bit is established. (3) Based on the composite ABAQUS model, and analysis of the influence of the change of the rake angle and the angle of the side slope on the rock breaking effect, then, draw a conclusion. In this study, we establish the model of PDC composite, and the computer simulation of the bit is realized.

Keywords

PDC composite sheet; computer simulation; anterior angle; heeling angle; cutting force .

1. Introduction

1.1 Purpose and Significance of Research

Poly crystalline Diamond Compact Bit is made of synthetic polycrystalline diamond Mosaic or welded on the bit itself and become a bit cutting type, was developed in 1970 s. The PDC bit in the drill the formation such as soft, hard, have good efficiency, the drilling speed work long hours to break rock and high reliability and can bring high economic benefits, thus in the world in the field of oil and gas drilling to obtain the more widespread use, while the demand of PDC bit increases year by year, also proposed on the performance of the bit itself becomes more and more high demand

Want to in-depth analysis of the bit performance at work, we must first understand the interaction between the bit and rock at work, but now we have no way to find out the relationship between the two, so just a theoretical analysis is far from enough. Though it is now in the practical work situation can be detected, and load on bit and drill down under artificial control strata and the speed of the bit drilling process for research is not enough, because the process of rock damage and the complicated downhole conditions are difficult to measure Therefore, it is difficult to make a deeper analysis of the bit performance based on the data obtained from the actual work site. In order to complete the inquiry, the researchers tested in the laboratory to study the performance of the bit, but the test result is not ideal, in the process of experiment, the researchers found that the bit is not only affected reasons, many parameters of the drill bit will affect the effect of rock fragmentation, and different rock also has different properties, so a bit in the process of rock damage, do not have uniqueness, its performance is random.

This study mainly completed the establishment of PDC composite chip model, and further understood and explored the interaction between PDC composite chip and rock by using computer simulation, which is of great significance to the research of PDC bit.

1.2 Technology status at home and abroad

1.2.1 Technology status at home and abroad of the PDC Bit

With the continuous progress and development of the society, petroleum has become one of the indispensable energy sources at present. In order to continuously improve the PDC bit performance, bit researchers at home and abroad have devoted a lot of time and energy to improve the bit design methods including material manufacturing technology and other aspects[1]

Technology status at home

In the 1980 s, based on the average bit, PDC bit can significantly improve the drilling efficiency, and has obtained the widespread application [2] in our country, in order to improve the production capacity of oil and gas fields, improve the production efficiency of well site, the researchers tried to use in mining PDC bit [3] although the PDC bit is to drill has good work performance, but because our country in this aspect research level is limited, the quality of PDC bit is not ideal, therefore, in the next few years, numerous conducted on PDC bit workers Drill bit research

Technology status at abroad

Over the years, in order to meet the requirements of various complex oil and gas drilling conditions and conditions, various bit research and development companies (especially the United States) have developed a variety of high-tech new bits, such as

Smith Bits

The company introduced a large number of new PDC drill products, including :ARCSTM 、 Velocity TM, etc. In order to improve the working ability of the bit and extend the working life of the bit, the four main parameters of the bit (stability of the bit, mechanical drilling speed and durability, and steering performance) become the main objects of their improvement

TOUGH-DRILL Bit

Through simulation software simulation analysis, the researchers found that geometry, through improved tungsten carbide interface can effectively overcome the problems with abrasive hard formation improved PDC bit has a better ability to resist shock, we also analyze the polycrystalline diamond grade study, through the selection and use of with pertinence, to a certain degree can improve the bit wear resistance [3]

1.3 Mechanical study of composite plates

Today at home and abroad in terms of PDC bit of research work, also focused on the interaction between the bit and rock, the PDC bit workload and cutter efficiency mainly depends on the size of the bit drilling rate at work and in the lateral force of working hours, PDC composite piece of selecting parameters of the cutting force is reasonable, a large extent, impact assessment, therefore, the design of drill bit cutting teeth the stress problem of all bit makers tend to be very care about they invested a lot of theoretical and experimental research work is applied to the analysis of the condition of the cutting force, which representative the following research

Foreign research results

In 1992s. Researchers DE turnay and DE furni from the schlumberger Cambridge research center in the United Kingdom have presented a model for calculating PDC bit tooth cutting loads

New tooth : $F_{SC} \quad S \dots F_{nc} \quad S$

model after wear: $F_s \quad (1 \quad) \quad S \quad F_n, \dots, F_n \quad F_{nc} \quad F_{nj}$

In the above equation, the cutting force borne by the bit surface parallel to the cut surface is represented by Fsc, and the cutting force borne by the bit surface perpendicular to the cut surface is

represented by F_{nc} . The force on the blunt tooth in the horizontal direction is expressed by F_s , and the force perpendicular to the horizontal direction is expressed by F_n . The normal force on the wear plane of blunt teeth is F_{nj} . Section area is indicated by S . E is the energy per unit mass of the rock itself, and μ is the value of the horizontal force on the vertical force ratio of the blunt tooth; μ_d is the dynamic friction factor between the cutting tooth broken rock surface and the broken rock

Computer aided design and overall simulation technology design are the methods adopted by most PDC bit manufacturing companies, so as to obtain the most reasonable bit geometry tooth distribution scheme and hydraulics parameters, etc., so as to make the designed bit reach the optimal level

Research Thought and Main Content

Research design

The research idea of this paper is through the computer simulation of PDC composite drilling process, to understand the rules of PDC bit compound piece of work, and by changing the former PDC bit Angle and roll Angle, as well as the reference of ABAQUS finite element software and related knowledge of the finite element method, finite element analysis model of PDC bit cutting teeth and to analyze different Angle and roll Angle of the influence of rock fragmentation, quantitative conclusion

Research contents

Establishment of simulation model

The simulation model of rock and composite sheet was built by Pro/E software and imported into the ABAQUS software. The rock and composite sheet models were respectively represented by cuboid and cylinder

Set the model parameters

Mesh generation assembly definition boundary conditions definition motion form and set up the analysis step

Carry out simulation calculation

The results are postprocessed and the rules are obtained

Effect of rake Angle on rock breaking effect

Take 16 mm diameter rock fragmentation process simulation, shale as a test of rock [4], simulation, set the cutting depth is 3 mm, tilting Angle of 0 fixed value is constant, variable Angle before starting from 0.0° , 5.0° test interval, the interval (15° , 25°), every 2.5° test time, the current Angle is 30° after the test, stop the test, and sums up the good simulation results

Influence of side inclination Angle on rock breaking effect

A tooth with a diameter of 16mm was selected to simulate the rock breaking process, and shale was selected as the test rock. The cutting depth was set as 3mm, the rake Angle was set as 15 constant, the variable side inclination started from 0.0, and the test was conducted at intervals of 2.5. When the test ended with a side inclination of 20, the test was stopped, and the simulation results were summarized

PDC bit and its working principle

Bit profile

Combined cutter and bit body of cutting type bit, the drill bit for polycrystalline diamond composite sheet material, and is not a simple means of adhesion, but strength greater welding or Mosaic, we call this kind of bit PDC bit is one of the most commonly used to comprehensive drilling bit (figure 2.1) overall structure is mainly composed of three parts: the bit of the tire carcass body on the distribution of compact and can complete the cooling fluid jet nozzle in terms of material and manufacturing process, the PDC bit can be divided into the following two

Steel body bit: the strength of the blade height will not affect the modelling of steel body, bit crown subject has very high strength, and composite brazing strength is also very high, if there is damage in

use, later also is very easy to repair, the manufacturing process of steel body bit short, manufacturing efficiency is high, and only need a steel body ontology as raw material, the cost is not high, more than the tire body bit has the advantages of

Bit: carcass with cast tungsten carbide powder and impregnated material, just rely on shock vibration to control the interior of a bit density, then heat melt adhesive metal impregnated molding method and form the shape of the mould can indirectly influence the bit body shape mould by the end of die in the die and the three parts of upper die mould in addition to the bottom die is difficult to control, easy to control all bottom die contains very complex curved surface, a little bit of difference, will affect the structure parameters of PDC bit position parameters of the compact, etc



Figure 1 PDC diamond bit

How the drill works

Bit of broken rock way belong to shear (as shown in figure 2.2) shear rock this way under the same effect of rock fragmentation, not high to the requirement of power, so it is a bit of a major bright spot, other bit has high efficiency in the practical work, have good wear resistance and with compact sharpness is at work, which is closely linked by different kinds of acid erosion, cutter blade will occur to a certain extent of passivation, and abrasion resistance is good or bad, is to determine the speed of passivation; In addition, the cutter after passivation wear, could not immediately on the replacement, so how to make its continue to break rock drilling, depends on the sharpness of the high and low, due to the difference between the larger wear resistance exists in the compact between the diamond layer and carbide substrate (over 100 times), so the wear on the substrate and tooth edge occurs at the same time, because of matrix wear resistance than a tooth blade abrasion resistance is strong, so the matrix will be relatively quickly wear out, so at this point, the tooth edge parts of the diamond layer of slower as a result of wear and tear, so it can keep the blade sharp, complete broken rock, this is the tooth sharpness

2. Mechanical properties of rocks

When external force, the study of rock under the condition of stress situation of strain and damage mechanical properties such as [44] discipline called rock mechanics, rock mechanics includes two features: the strength of the rock properties and deformation characteristics before the said rock specimens pressed, destroyed the instant of maximum stress (i.e., ultimate strength) and relationship between damage; On the one hand, the maximum stress value can show the resistance ability of rock to failure; on the other hand, the relationship between the two can show the rule of failure occurrence. The latter shows the rule of rock specimen changing its original form under different pressure, which is a macroscopic expression of rock mechanical properties

Types of rock deformation

When each particle in the rock leaves its original position and reaches a new position, we say that the rock has undergone deformation. There are many factors that can cause rock deformation, among which the following three are common

elastic deformation

Said rock porous media by outside force, gradually changing shape, and there is no evidence of flow and destruction, and when to remove the external force, porous medium can be fully restored to the original state of rock deformation in essence, a kind of elastic deformation because of the external force between exists within each point of rock damage, the original keep dynamic balance state, the particle deviates from the original position, to another location, in the new position, is another kind of balance when the external force to remove, in under the action of forces, rock within a particle goes back to the original location, at the beginning balance

plastic deformation

Said rock porous media by outside force, gradually changing shape, and when the pressure back to its original condition, has been the deformation of rock will not be able to leave the existing internal particle position, the position of the back to the original form on the deformation, was called said plastic deformation plasticity of rock, need a dimension to reflect, this dimension is the plastic coefficient of plasticity coefficient k is defined as, under the bit/rock interaction, the rock the energy needed to power a elastic deformation and plastic deformation occurred the sum of the energy needed to power and the ratio of strain energy

elasto plastic deformation

When the rock in the event of elastic deformation, before the impending plastic deformation, the rock elastic-plastic deformation stage, the stage, said after the external forces to withdraw a portion of the rock elastic is better, so the inside of the rock particles can be gradually restored to the position of the beginning, and apart from this part of the other part will continue in after applying force to achieve the balance, will no longer return to the first position in the actual exploitation of oil and gas, due to the changes of many environmental factors, and does not allow the rock to the contact is pure plastic or elastic deformation Mainly exists in a kind of intermediate deformation, that is, elastic-plastic deformation

3. Simulation and result analysis

ABAQUS simulation software

ABAQUS Is a kind of engineering simulation finite element software which drill bit researchers often use. Abaqus can be applied to both linear and nonlinear problems in practical engineering. ABAQUS contains many common shapes, which can be simulated in a wide variety of ways. In order to deal with the typical materials encountered in practical work, the performance of these materials can be simulated in various aspects. There is a material warehouse in abaqus where includes the kinds of metals that are very elastic, the kinds of metals that are very common, the kinds of metals that are made up of many different materials, the kinds of geological materials that are common at the bottom of the well, such as rocks and soils, Abaqus software is not only used in mechanics, it can also solve some problems in other fields, including thermal and electrical simulation analysis.

Establishment of simulation model

Model import

For the model of composite sheet and rock, we choose cylinder and cuboid to replace it. Therefore, we first establish the model of composite sheet in ProE, and then save it into the format required by the import of ABAQUS, and then import ABAQUS for further processing and analysis, as shown in figure

The models are listed below:

When building the rock model, we set its length as 400mm, width 250mm and height as 50mm, as shown in figure 4.5

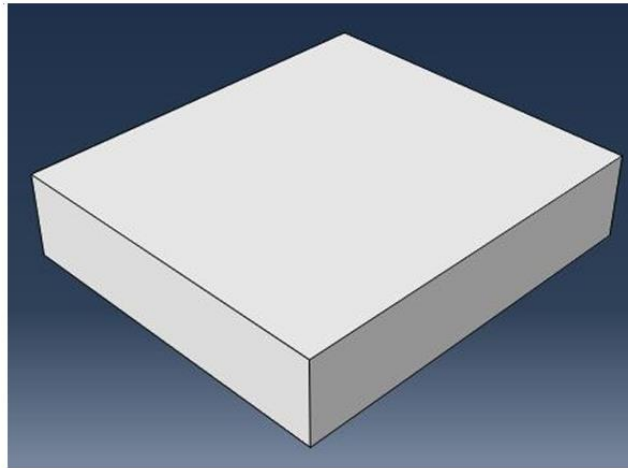

Figure 2 Rock model in simulation software

When the composite sheet model is established, its diameter is 16mm and thickness is 10mm, as shown in figure:

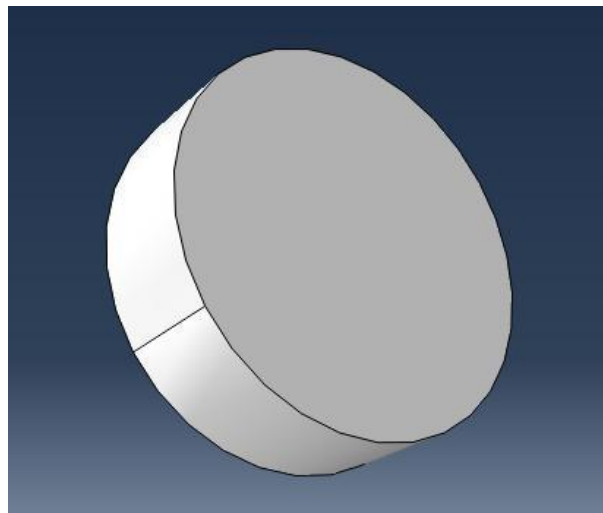

Figure 3 Simulation software in the composite chip model

Set material parameters

In this simulation test, we chose shale as the test rock sample. We set the young's modulus of the rock as 21Gpa, poisson's ratio as 0.3, strength limit at normal temperature and pressure as 250Mpa, internal friction Angle as 50, cohesion force as 40Mpa, etc. The parameters are shown in table 1

The basic parameters of rock in the simulation model

rock material	Young's modulus MPa	Poisson's ratio	ultimate strength MPa	internal friction angle	cohesion MPa	density
页岩	21000	0.3	250	50°	40	2.65E-009

Alloy steel is selected as the composite material. Its density is set as 7.8E-009, elastic modulus is 206Gpa, and poisson's ratio is 0.3. The details of parameters are shown in table 2

The basic parameters of composite chip in the simulation model

Composite sheet material	diameter mm	density	Young's modulus MPa	Poisson's ratio
alloy steel	16	7.8E-009	206000	0.3

mesh generation

Grid is the important guarantee of analysis for meshing is compact and rocks is simpler, when carries on the grid, the rock model grid size is set to 2, compact model of grid size is set to 1, which reduces the capacity of the computer, the rest of the parameter selection of the system default parameters unchanged

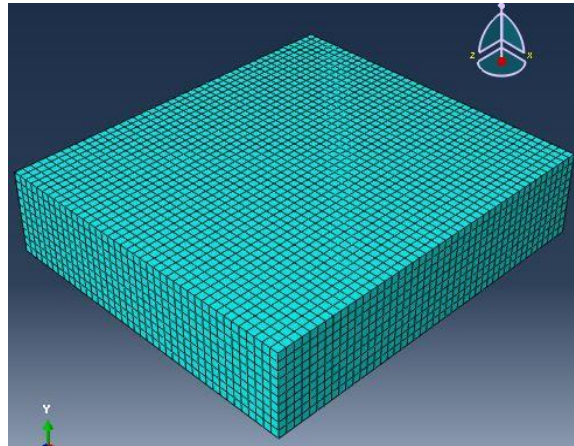

The meshing of the rock model is shown in figure 4.

Figure 4 Meshing of rock models

Mesh generation of the composite slice model is shown in figure 5

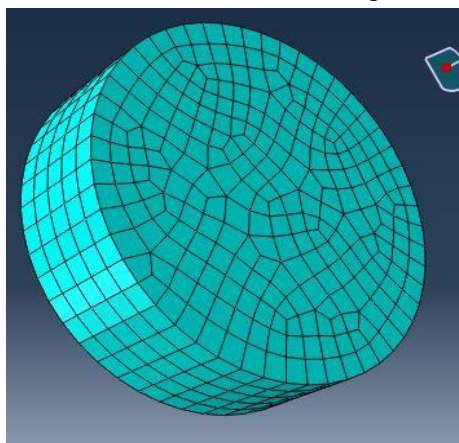

Figure 5 Mesh generation of composite slice model

Assembly of model

After the rock and composite model are established respectively, the model is assembled so as to show the relative position relation and interaction process between the composite and rock

Here are two major positional relationships:

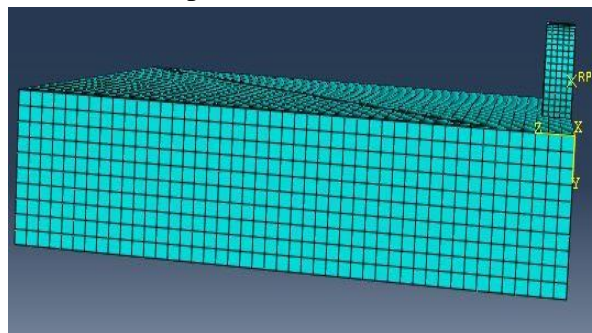

Figure 6 Assembly drawing when rake Angle is 0

When the rake Angle is 0, as shown in FIG.6

When the rake Angle is 15, the inclination Angle is 5, as shown in FIG. 7

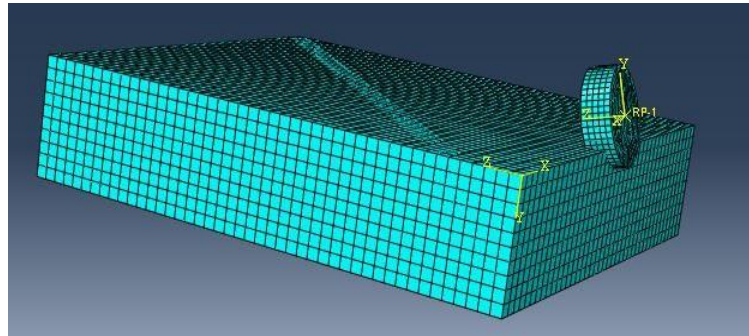

Figure 7 The assembly drawing when the inclination Angle of 15 sides is 0

Motion form setting

Set is an important step of analysis for the moving form, is mainly used for realizing movement of drilling bit and rock contact relationship established in this experiment, the tooth contact with rock model for everything, we set the rock except on surface are mobile, the rest on the surface of the moving mass were 0, so that we can ensure the rock in the process of the simulation will not because of their mobile lead to inaccurate measured stress second, compact only on perpendicular to the direction of the force on the surface of the campaign, not up and down or left and right to move in addition, rock and compact are parallel movement, no rotation, as shown in figure 8.

Analysis step setup

In this test, we mainly use the analysis step to control the cutting Time of the composite sheet. We set its Time period as 2s, that is, the drilling Time as 2s, as shown in FIG. 9

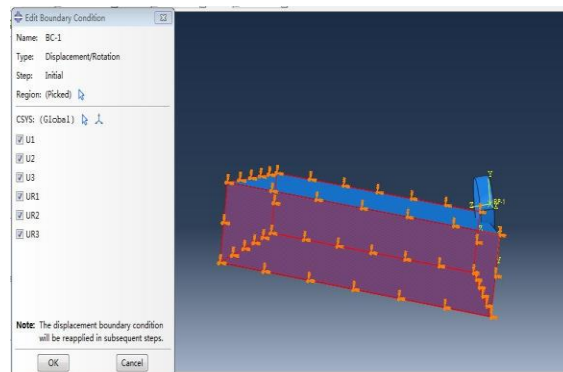

Figure 8 Definition of rock contact with composite plates

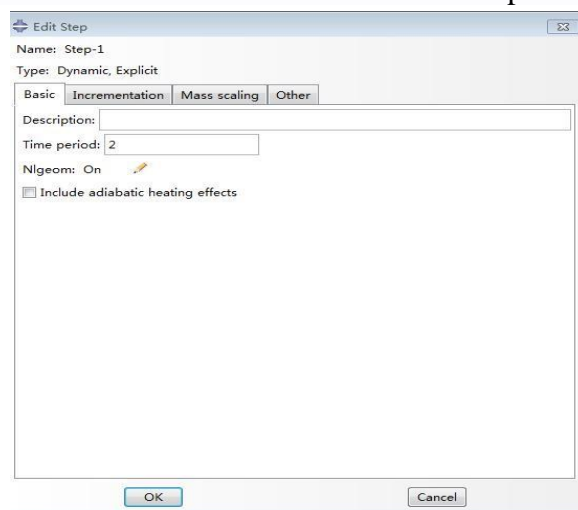

Figure 9 Analysis step setup

Cutting speed setting

The PDC bit selected in this test has a diameter of 8 inches and a half (21.59cm) and a rotation speed of 100rpm, and then the cutting speed

Calculate the available, $V_c = 183.43\text{mm/s}$, See figure10

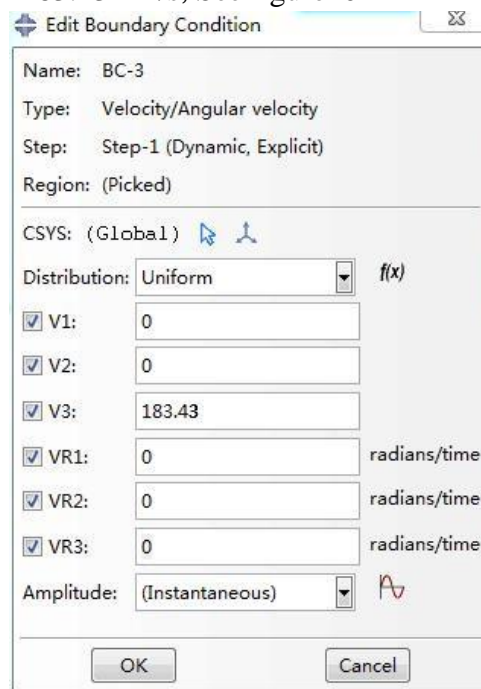

Figure 10

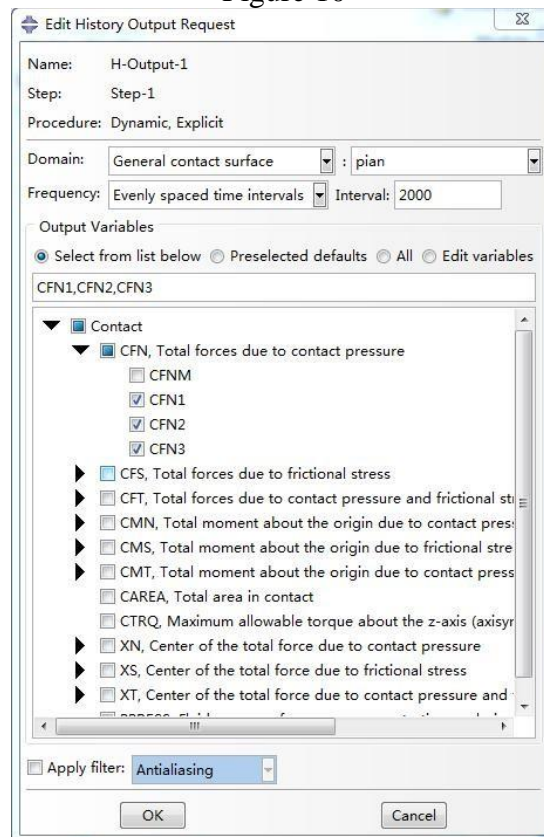

Figure 11 Setting of output force

Setting of output force and output surface

Setting of output force

In the simulation experiments, through research, we need to determine the effect of rock fragmentation is good or bad, so we will come out from XYZ three axes, respectively, by means of

the power output of the three axis, can the size of the resultant force is obtained by calculation, which can be concluded that the effect of rock fragmentation and below is the output force of the interface, as shown in figure 11

Output surface setting

We need to select a plane and obtain the forces required on the above three axes of XYZ by studying the forces on the plane. In this simulation, we choose the cutting surface of the composite plate as our output surface, as shown in FIG 12.



Figure 12 Output surface setting

Touch the right Settings

Alleged contacts for setting up, it is set on the rock surface and complex piece of cutting face to a pair of mutual contact plane, then the simulation software will also on the relative movement between the two sides, and by force will reflect the process of interaction in the form of this simulation, we will compact set to the first contact, the rock is set to the second interface, as shown in figure 13

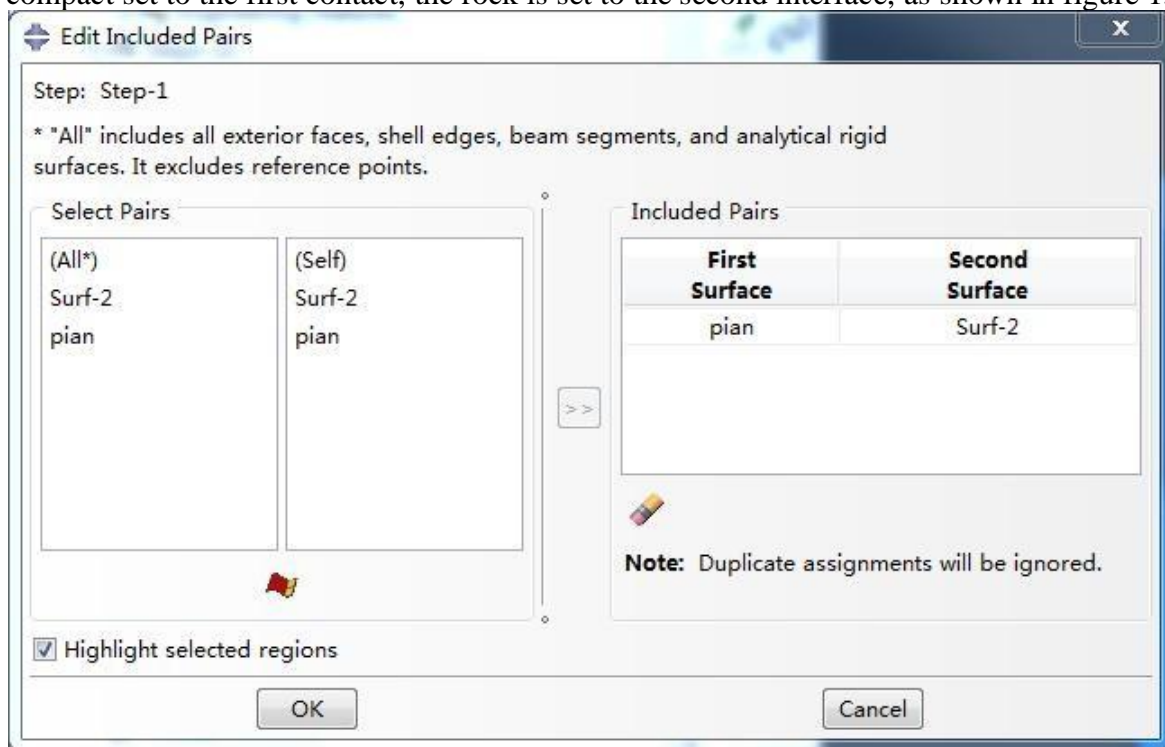

Figure 13 Touch the right Settings

job submission

JOB module is mainly used for setting computer parameters and submitting operation. During operation, the operation state is monitored.

interpretation of result

Simulation results of rake Angle

ABAQUS simulation was carried out on the rake Angle of different angles successively, where: when the current inclination is 0 and the side inclination is 0, the force curve on axis XYZ is as follows

Forces on the X axis are shown in FIG. 14

2. Forces on the Y axis are shown in FIG

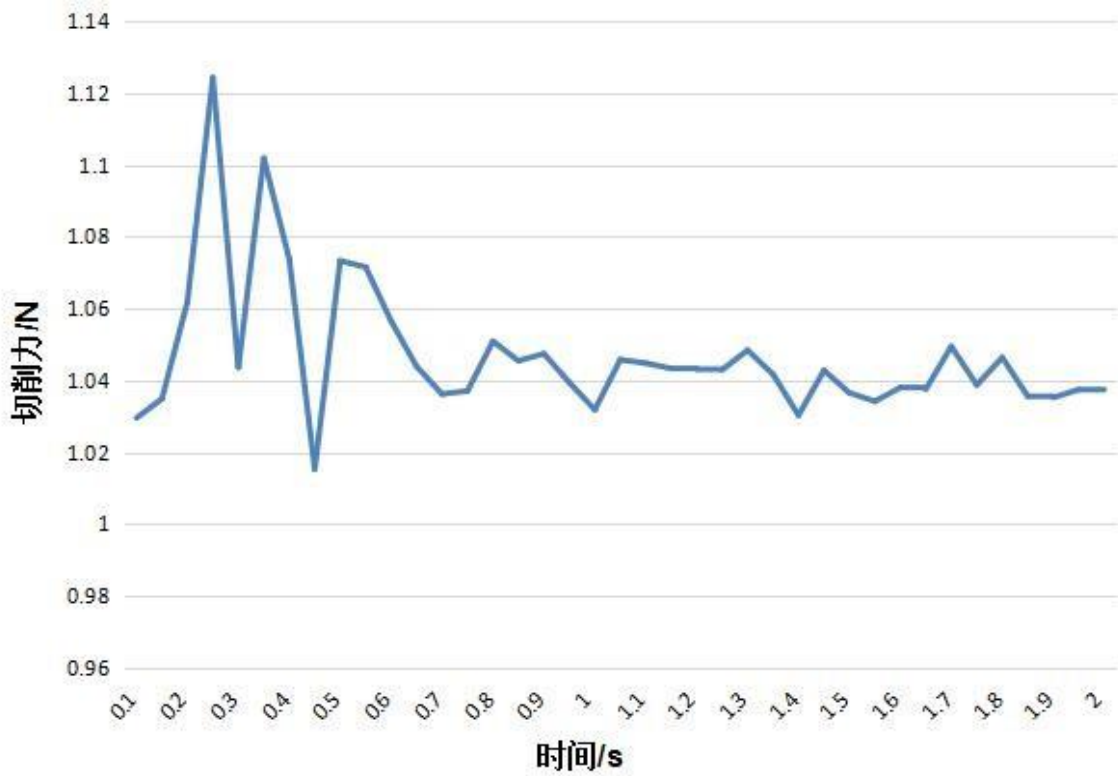
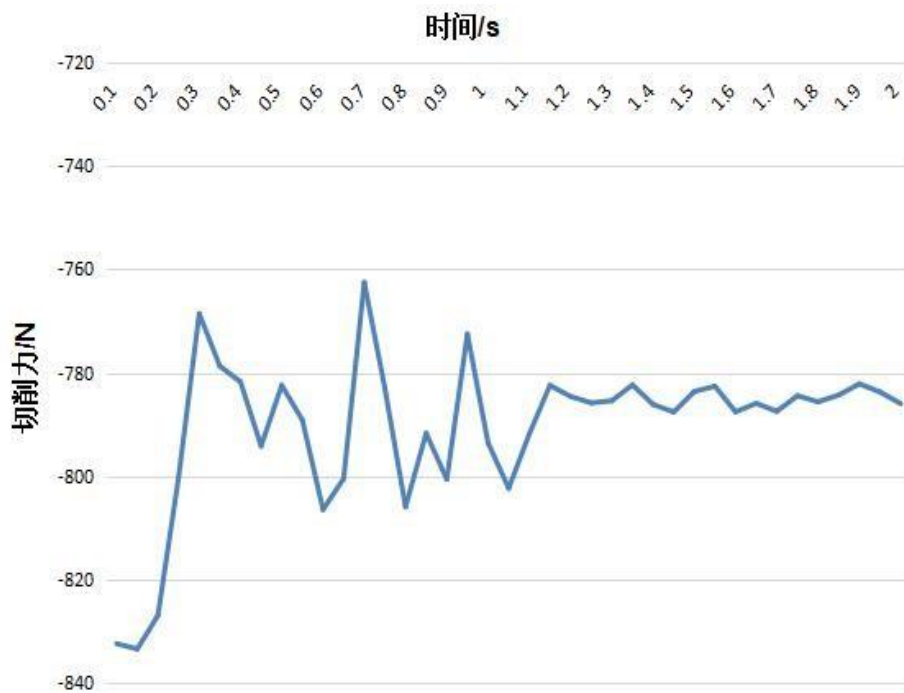
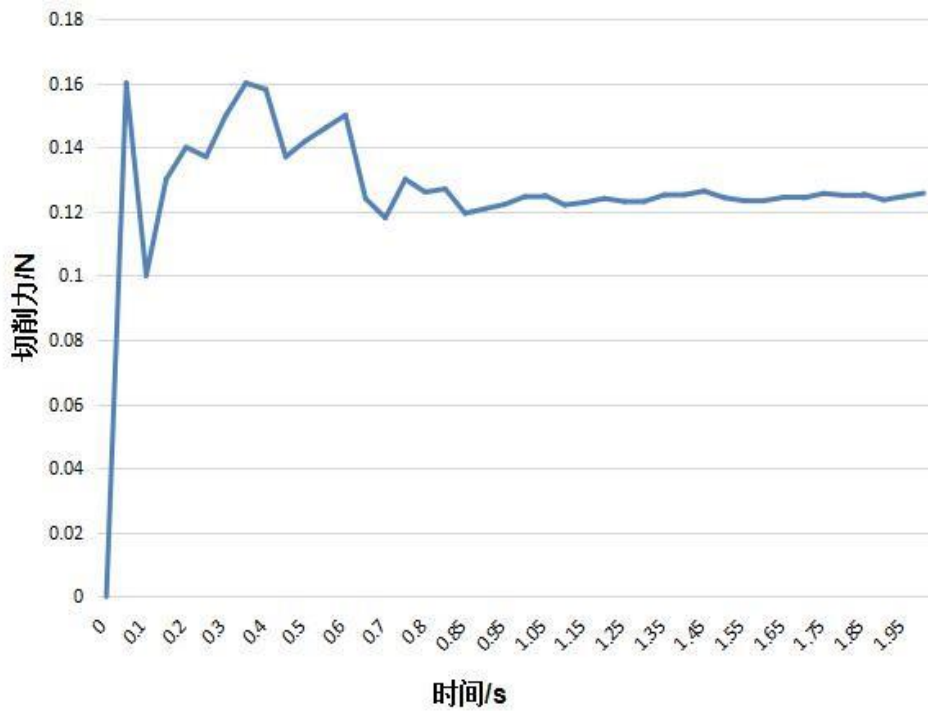

Figure 14 The force diagram on the X axis



3. Forces on the Z axis are shown in FIG



When the current inclination is 15 and the side inclination is 0, the force curve on axis XYZ is as follows

Forces on the X axis are shown in FIG

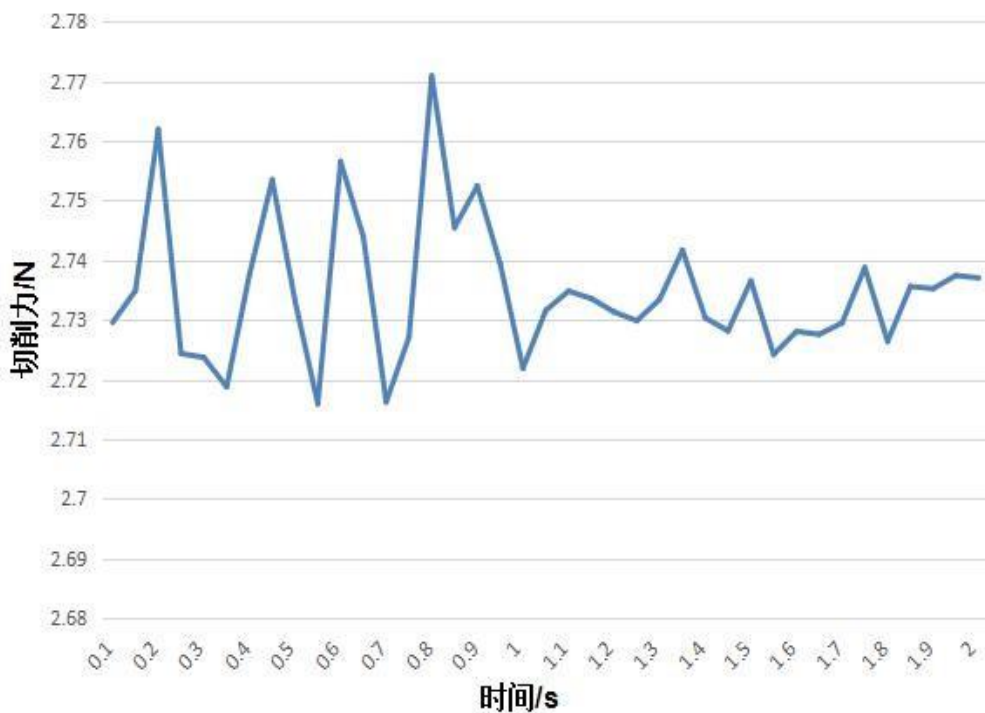

Forces on the Yaxis are shown in FIG.

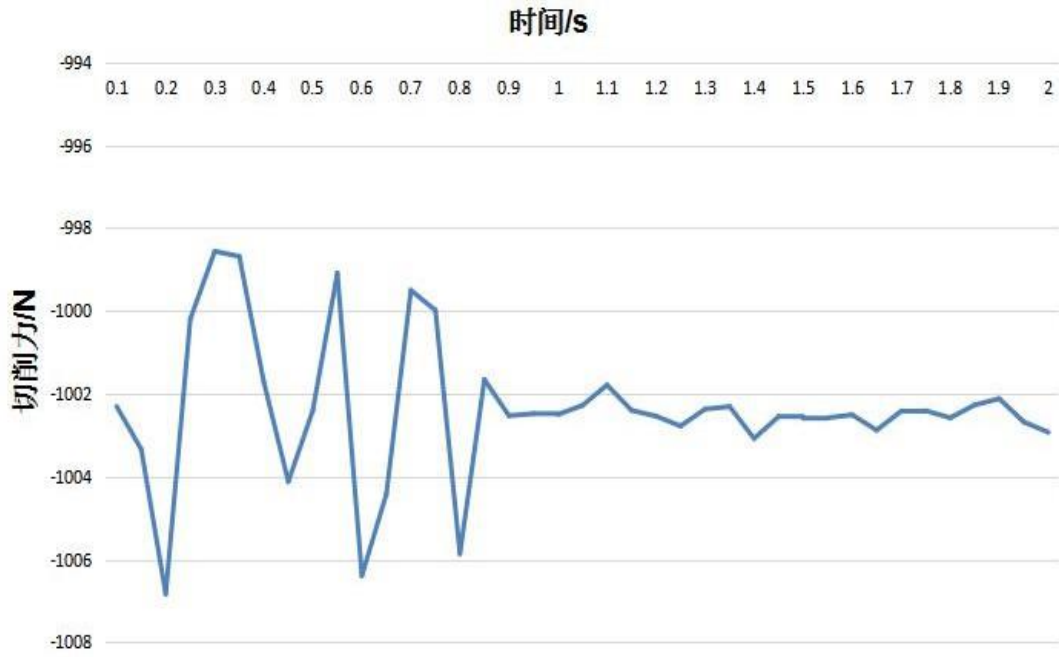

3) Forces on the Z axis are shown in FIG:

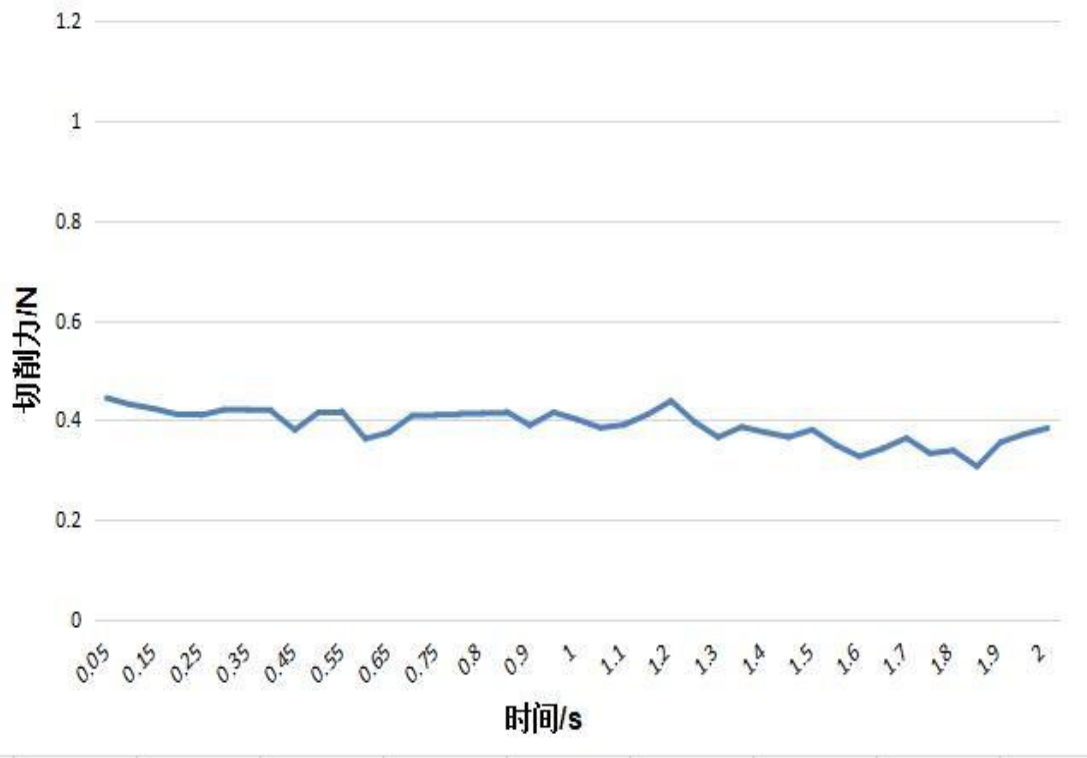

Cutting forces under different rake angles are shown in table 4.3 below

Simulation results of different rake Angle

Degree of rake (°)	The average force on the x axis (N)	The average force on the Yaxis (N)	The average force on the Zaxis (N)	mean force (N)
0°	1.027	-785.265	0.128	786.359
5°	2.556	-1124.262	0.485	1124.535

10°	2.646	-1353.298	0.467	1353.981
15°	2.733	-1001.912	0.359	1001.916
20°	2.812	-1205.231	0.384	1206.358
22.5°	2.964	-1295.598	0.402	1296.561
25°	2.855	-1518.065	0.458	1519.026
30°	2.734	-1193.988	0.472	1195.235

Brief summary

By the graph, you can see that in the interval (0 ~ 10), the average cutting force continues to increase this shows in the area in between, when the drill bit broken rock impact load is very fierce, although it is advantageous for rock fragmentation, but rapidly increasing load will cause very big effect to cutting tools and other drilling tools, therefore, although the range of broken rock is very fast, but in order to protect the safety of downhole drilling tools, the area is not suitable for the actual drilling in between;

although the overall cutting force presents an increasing trend, due to the inherent mechanical properties of the rock itself, the increasing trend of cutting force presents a wave-like shape;

When the current dip Angle is in the interval (15 ~ 25), the average cutting force increases gradually, and the cutting force is positively correlated with the rake Angle

When the current inclination Angle is 25, the average cutting force reaches a peak of 1519.026n

Therefore, if the cutting force is taken as the evaluation parameter of rock breaking effect, considering the protection of cutting teeth comprehensively, it is recommended to use the bit with the rake Angle in the interval (15 ~ 25) for rock breaking, because in this interval, cutting teeth not only have better rock breaking effect, but also have a long service life

Simulation results of side inclination Angle

When the current inclination Angle is 15 and the side inclination Angle is 5, the force curve on axis XYZ is as follows

Forces on the Xaxis are shown in FIG. :

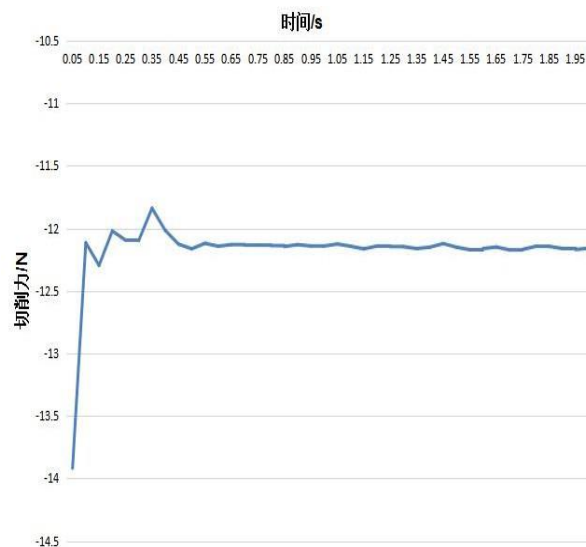

Forces on the Yaxis are shown in FIG. :

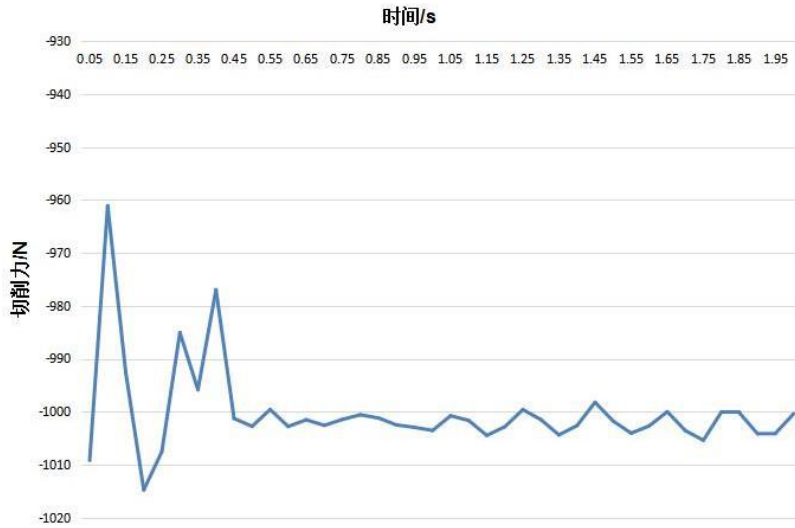

3. Forces on the Zaxis are shown in FIG.

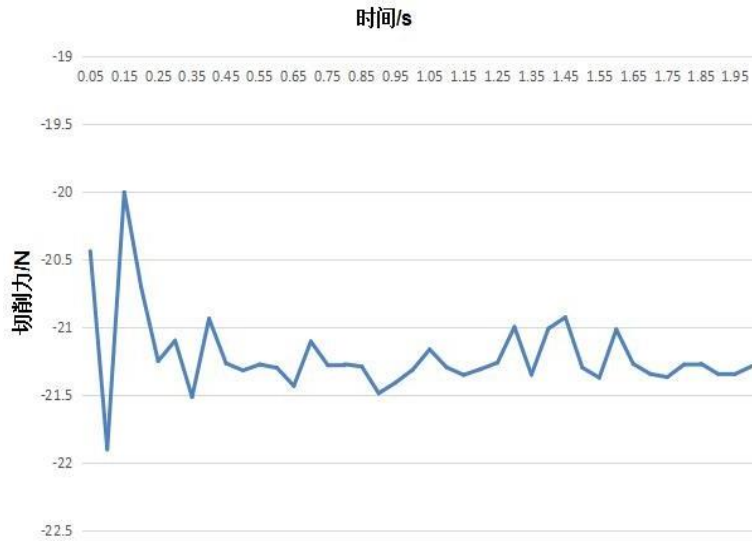

When the current inclination Angle is 15 and the side inclination Angle is 15, the force curve on axis XYZ is as follows

Forces on the Xaxis are shown in FIG. :

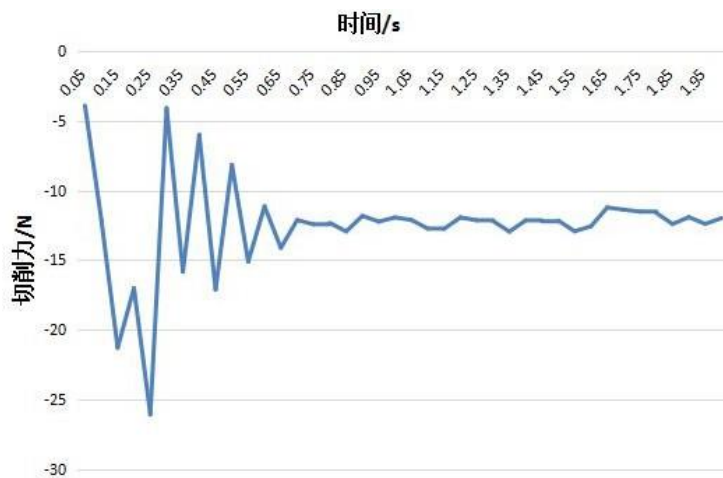

Forces on the Yaxis are shown in FIG.

Forces on the Zaxis are shown in FIG.

Cutting forces under different side inclinations are shown in table

Simulation results of different side inclination Angle

Angle of roll (°)	The average force on the x axis (N)	The average force on the Yaxis (N)	The average force on the Zaxis (N)	mean force (N)
0°	-11.986	-1199.016	-22.598	1200.268
2.5°	-12.015	-1122.568	-22.651	1123.354
5°	-12.262	-998.982	-22.763	999.317
7.5°	-12.126	-1105.896	-22.826	1106.549
10°	-12.065	-1024.672	-22.712	1025.238
15°	-12.206	-1008.986	-22.659	1009.498
20°	-11.988	-956.026	-22.601	956.572

Change curve of cutting force with side inclination Angle

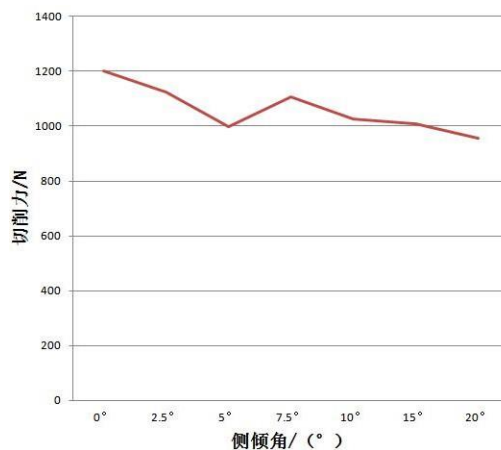

Brief summary

It can be seen from the graph that the average cutting force decreases gradually in the interval (0 ~ 5) 2) In the interval (5 ~ 7.5), the average cutting force increases gradually, while in the interval (7.5 ~ 15), it decreases gradually

However, the change range in the whole range of (0 ~ 15) is not large, and the overall force is relatively stable

Therefore, according to this simulation, if the cutting force is taken as the evaluation parameter of rock-breaking effect, it is recommended to use the bit with side inclination Angle of 5 and 15 to conduct rock-breaking, because in this interval, the cutting teeth not only have a good rock-breaking effect, but also have a long service life.

4. Research conclusions

Simulation result

PDC Bit performance analysis technique is the core of its mechanical performance analysis, and mechanical properties of the bit and the teeth in the process of rock cutting force analysis on the basis of the domestic study on the basis of diamond bit technology is relatively weak, so the effect of rock fragmentation of PDC bit cutting teeth system research is particularly important in this paper, numerical simulation with finite element analysis software ABAQUS, obtained the data

After referring to the geometric simplified models of rocks and drill bits in relevant literatures, the simplified models of rocks and composites were established in this simulation. Cuboid was used to replace the rock model, cylinder was used to replace the composite chip model, and a series of operations, such as setting of meshing boundary conditions and setting of performance parameters, were carried out for the two models

The two independent models were assembled, and the relative positions of the rock and composite sheet models were changed during the assembly process, that is to say, the changes of rake Angle and side inclination were completed in the actual process

The finite element analysis method was used to simulate the rock-breaking effect of PDC composite sheet under different angles. By changing the rake Angle and side inclination Angle, the change of the interaction force between the rock and composite sheet was observed, which was shown in the form of charts

After the interaction between the composite sheet and the rock, the equivalent stress on the PDC composite sheet shows a strong fluctuation, and the fluctuation has a periodic rule. With the passage of time, the average stress on the composite sheet changes constantly

Current Angle is located in the interval (0 ~ 10), the average cutting force continues to increase this shows in the area in between, when the drill bit broken rock impact load is very fierce, although it is advantageous for rock fragmentation, but rapidly increasing load will cause very big effect to cutting tools and other drilling tools, therefore, although the range of broken rock is very fast, but in order to protect the safety of downhole drilling tools, the area is not suitable for the actual drilling in between

When the current dip Angle is located in the interval (15 ~25), the cutting force is positively correlated with the rake Angle. When the current inclination Angle is located in the interval (15-20), the cutting force is small and the increase rate is relatively slow, which will not cause high strength impact on the drill bit and have relatively good rock-breaking effect. When the inclination Angle is located in the interval (15-17.5), the cutting teeth have a long service life and are not easy to be damaged

7) Cutting teeth roll Angle of the main effect is to improve the cutting teeth of chip removal ability, prevent the bit balling, can be seen from the simulation, the roll Angle (0 ~ 15) in the whole range, compact average cutting force have increased, the whole little change when the roll Angle in 5, and 15, the average cutting force is small, have relatively good effect of rock fragmentation, and not easy damaged, a longer service life

Open question

In the actual simulation process, because of the limited function of the simulation software, we simplified the circular track cutting movement mode of the cutting teeth in the actual work to the linear track cutting, and the difference of such movement mode may have certain influence on the rule of composite sheet breaking

The simulation doesn't consider the actual drilling condition of some parameters, such as drilling fluid pressure confining pressure, the bit cutting teeth working environment there is a difference in the actual drilling conditions, the stress state of the rock is much more complicated than under the condition of normal pressure in the ground, and constantly in the process of drilling, along with the high speed drilling bit, is bound to cause the change of temperature, it also has certain influence to a bit of work

In the drilling process, there must be a large amount of drilling fluid in the contact area between the composite sheet and the rock. However, this simulation test was completed without considering the effect of friction, that is, the influence of lubrication of drilling fluid on the rock-breaking effect was ignored

The model of the rock is relatively single, which cannot fully explain the rule in all cases. In fact, the properties of the rock are not unique, and only one kind of rock is selected as the sample in this simulation

References

- [1] Tetsuji O, Hirokazu K. Cost Reduction of Polycrystalline Diamond Compact Bits through Improved Durability[J]. *Geothermics*, 2002, 31:245-262.
- [2] Robert Clayton, Shilin Chen, and Guy Lefort. New Bit Design, Cutter Technology Extend PDC Application to Hard Rock Drilling[J]. *Society of Petroleum Engineers*, 2005, 24(15).
- [3] Edward J. Schell, Duane Phillippi, Robert T. Fabian. New, Stable PDC Technology Significantly Reduces Hard Rock Cost Per Foot[J]. *Society of Petroleum Engineers*, 2003, 19(21).
- [4] Williams, J.L. and Thompson, A.I. Analysis of the Performance of PDC Hybrid Drill Bits[J]. *Society of Petroleum Engineers*, 2007:15-18.
- [5] [20] S. Johnson. A New Method of Producing Laterally Stable PDC Drill Bits[J]. *Society of Petroleum Engineers*, 2008, 23(3):314-324.
- [6] Warren, T.M., Sinor, L.A., Amoco Production Co. PDC Bits: What's Needed To Meet Tomorrow's Challenge[J]. *Society of Petroleum Engineer*, 2004, 29(31).
- [7] [23] E. Detournay and P. Defourny. A phenomenological model for the drilling action
- [8] of drag bits. *Int.J.Rock Mech.Sci.and Geomech Abstr*, 1992.29(1)
- [9] Mahmood Bataee, Rahman Ashena. Investigation of Various ROP Models and Optimization of Drilling Parameters for PDC and Roller-cone Bits in Shadegan Oil Field[J]. *Journal of Petroleum Technology*, 2010:1-4.
- [10] Cunningham R A. An empirical approach for relating drilling parameters[J]. *Journal of Petroleum Technology*, 1978, 30(6).
- [11] Warren T M. Penetration Rate Performance of Roller Cone Bits[J]. *SPE* 13259.1984.
- [12] Walker B H. Roller-bit penetration rate response as a function of rock properties and well depth [J]. *SPE* 15620.1986., 1995 17(3): 49-53.